



Regd. office:
Goldmedal Electricals Pvt. Ltd.
A/303, Kemp Plaza, Off Link Road,
MindSpace, Chincholi Bunder, Malad (W),
Mumbai-400064, Maharashtra, India

Web: www.goldmedalindia.com
Email: Info@goldmedalindia.com
Customer care no.: 91-9711 09 09 09

Goldmedal, Curve, Nixon, Air, Ringo,
Gifa & Cloud9 are registered trademarks
of Goldmedal Electricals Pvt. Ltd.
Copyright protected by Goldmedal. No part of this
pricelist & catalogue may be printed or duplicated
without consent of Goldmedal Electricals Pvt.
Ltd. Patent, Trademark & Designs protected.
Infringement is liable for prosecution. Imitation
of graphics is a punishable offence.
Brand Identity, concept & design of
Goldmedal Electricals Pvt. Ltd.



Scan for the
AMAZING

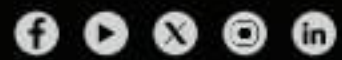

1ST EDITION MARCH 2K24

www.goldmedalindia.com



Switch to the amazing

EDITION - MARCH 2K24
PRODUCT & PRICING MANUAL





Experience the amazing!

Simply amazing!

How amazing can electrical switches, lights, fans, and wires be? Unbelievably so, if you look at the Goldmedal range of products. First of all, they are all so fashionable to look at - from their sleek lines to their gorgeous colours and finishes, these products are a fashionista's dream come true. They can truly elevate any space with their stunning looks.

But you don't have to go by their looks alone. Consider their functionality and you'll appreciate why they are so amazing! Whether it is their home automation products or their fans or their LED lights or even simple products like switches and modular plates; every product has a unique design that has a purpose to it. Most of them are designed with Indian conditions, needs, and tastes in mind. Every product is thus a wonderful blend of style and functionality.

As someone who appreciates great style and loves incorporating such products in their daily lifestyle, I'm absolutely thrilled to be associated with the Goldmedal brand. Their products complement my sense of fashion and it's exciting for me to showcase these products to you! I hope you'll find them equally amazing!

Jacqueline Fernandez

Brand Ambassador

Jacqueline





Contents

Sec 01 Gifa Inserts	08-27
Sec 02 Gifa Modular Cover Plates	28-35
Sec 03 Video Door Phone	36-37
Sec 04 Curve Modular Inserts	38-51
Sec 05 Nixon Modular Inserts	52-69
Sec 06 Modular Cover Plates	70-87
Sec 07 Air Inserts	88-101
Sec 08 Air Modular Cover Plates	102-111
Sec 09 Junction Box	112-115
Sec 10 Curve Plus	116-137
Sec 11 Curve Plus Pro	138-141
Sec 12 Gazelle Wood Plates	142-143
Sec 13 Essenza	144-147
Sec 14 Urea Range	148-153
Sec 15 DBs & MCBs	154-183



i-TOUCH

GIFA F9 Absolute White Plate
With i-Touch Switches



Experience personalized automation, scheduling, and energy efficiency with the GIFA i-Touch switches. Powered by Zigbee technology, these switches offer unparalleled convenience and control. Enjoy effortless management of your lighting and appliances from anywhere with Zigbee's low-power, wireless connectivity. Revolutionize your homes and embrace the future of home automation with GIFA i-Touch switches, where simplicity meets sophistication, enhancing your lifestyle with every touch.



GIFA F9 Absolute White Plate with G-Style Switches & Regulator in Titanium Grey



F9
PLATES

The power that directly influences our soul.

Colour is a language that speaks directly to our souls. It has the ability to awaken our senses, ignite our passions, and create a profound impact on our overall well-being. It reaches deep within us, stirring emotions, evoking memories, and shaping our perceptions of the world. From the vibrant radiance of a sunset to the subtle tones of a delicate flower petal, colour possesses the profound capacity to transform our moods, uplift our spirits, and ignite our creativity. So, let us embrace the vibrant palette that surrounds us to enrich and transform our lives in ways we may not always realize.

GIFA presents the Smart Dock that can be a smart companion to your smartphone! At rest, the Smart Dock remains flush with the cover plate. Apply gentle pressure on the unit and it springs out into position. Simply place your phone on the console to get it charging. Along with listening to FM, you can also listen to the music on your phone, plus make, receive, reject and end calls, as well as control the volume of the phone and change music tracks. And you can do all of these with the help of buttons, voice control, and some even through hand gestures!



GIFA Ag Blue Sapphire Cover Plate with i-Dock in Titanium Grey

Sound never looked better!



Stereophonic Speaker - 2 Module

FM-Bluetooth Switch

Smart Dock 4 Module

Stereophonic Speaker - 2 Module



Bold. Contemporary.
Truly modern.

G-Style

The G-style switch lives up to its name with its breathtakingly modern and stylish appearance. An angular switch with defined body lines, delicately curved edges, and a metallic glaze finish, the G-Style has a striking presence in any setting. With its effortless symphony of form and function, the G-Style easily complements the aesthetics of every modern home.



G-Style
Ideal for modern interiors

G-Echo

G-Echo modular switches are characterized by sleek, clean lines with minimal embellishments. These switches, crafted for contemporary living, appeal to those who value a modern yet minimalist lifestyle. Made with superior-quality materials, this new range of modular devices promises to offer users a sophisticated experience.



G-Echo
Designed for modern lifestyles

G-Line

It doesn't get more minimalistic than this! The straight, clean lines of the G-Line, with its barest-minimum-possible protrusion over the cover plate surface, conveys the futuristic, minimalistic look that defines GIFA. Classically perfect, yet contemporary in styling, the G-Line is a pleasure to use at home and at work.



G-Line
Perfect crisp lines that define the Air range

Ultimate sophistication.

The GIFA range of modular inserts is minimalistic not just for aesthetic purposes but as a design philosophy. Represented by clear straight lines, crisp finishes, and minimum flourishes, these inserts are perfectly streamlined for optimum functionality. Deep thought has been given into the configuration and purpose of each product. The end result is an effortless symphony of form with function and class with comfort that will surprise and delight you on an everyday basis.



Fg Plate -
G-Style Switch with Indicator



Fg Plate -
I-Wave Switch

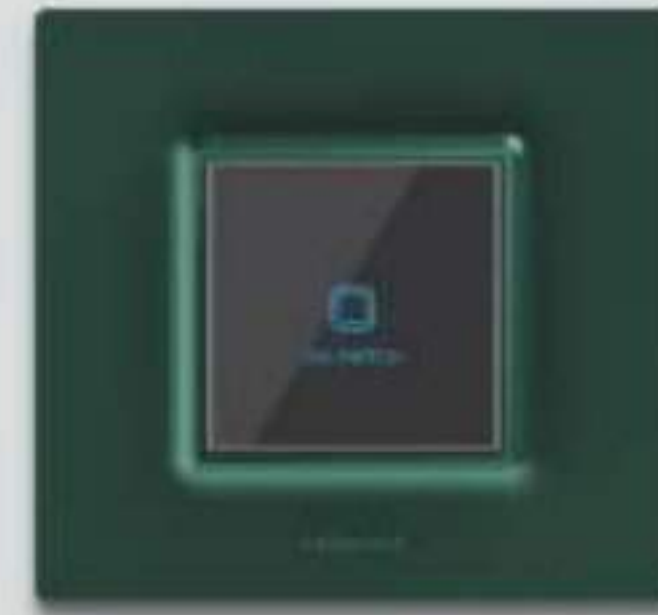

Fg Plate -
I-Touch 20A Switch



Fg Plate -
Smart Passive Infrared Detector



Fg Plate -
Lighting Fitting with Emergency Function

Fg Plate -
I-Push Step Marker

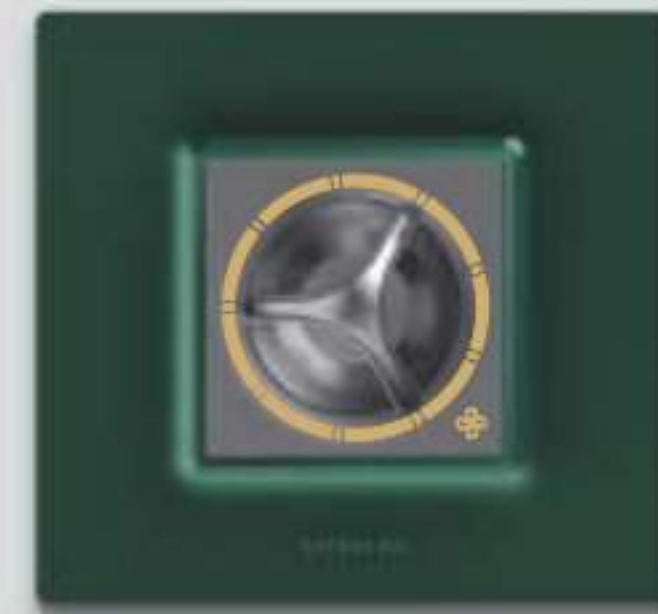

Fg Plate -
8 Step Fan Regulator Full Rotary



Fg Plate -
65W C Type Fast Charger

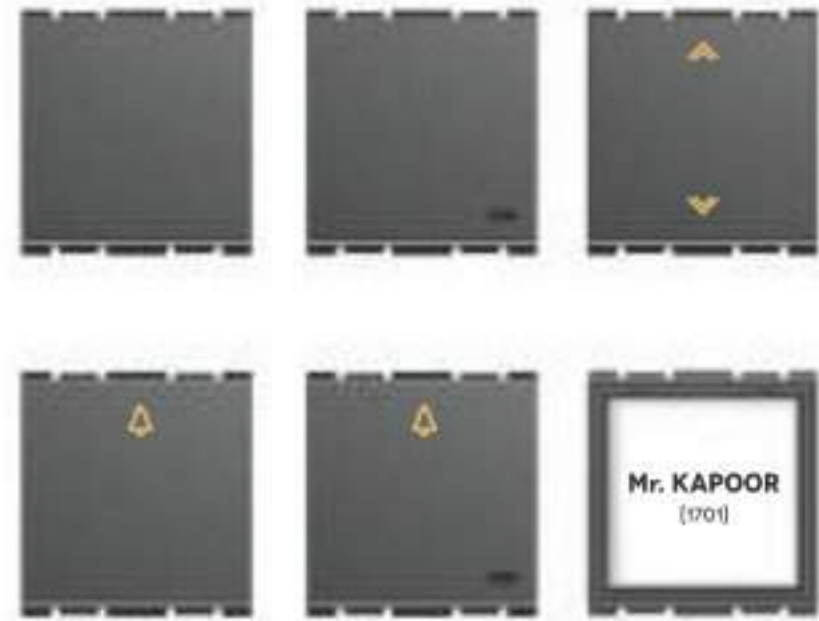

Code	Item	MRP ₹		Pkg.
		Absolute White	Titanium Silver Titanium Grey Stardust Grey	
10AX SWITCHES 240V- [1 Module] GLINE				
GF011001	1 Way Switch	78.00	85.00	20/600
GF011002	1 Way Switch with Indicator (LED)	139.00	156.00	20/600
GF011003	2 Way Switch	158.00	174.00	20/600
GF011004	Bell Push Switch	160.00	176.00	20/600
GF011005	Bell Push Switch with Indicator (LED)	169.00	185.00	20/600

Code	Item	MRP ₹		Pkg.
		Absolute White	Titanium Silver Titanium Grey Stardust Grey	
10AX SWITCHES 240V- [2 Module] GLINE				
GF012010	1 Way Switch	137.00	150.00	10/300
GF012011	1 Way Switch with Indicator (LED)	148.00	161.00	10/300
GF012012	2 Way Switch	213.00	234.00	10/300
GF012013	Bell Push Switch	213.00	234.00	10/300
GF012014	Bell Push Switch with Indicator (LED)	235.00	259.00	10/300
GF012015	Bell Push Switch with Luminous Name Plate	295.00	323.00	10/300

Code	Item	MRP ₹		Pkg.
		Absolute White	Titanium Silver Titanium Grey Stardust Grey	
20AMP / 25AMP SWITCHES 240V- [1 Module] GLINE				
GF011020	20A 1 Way Switch	212.00	233.00	20/600
GF011021	20A 1 Way Switch with Indicator (LED)	230.00	252.00	20/600
GF011022	20A 2 Way Switch	235.00	258.00	20/600
GF011023	25A 1 Way Switch	253.00	278.00	20/600

Code	Item	MRP ₹		Pkg.
		Absolute White	Titanium Silver Titanium Grey Stardust Grey	
20AMP / 25AMP SWITCHES 240V- [2 Module] GLINE				
GF012025	20A 1 Way Switch	232.00	254.00	10/300
GF012026	20A 1 Way Switch with Indicator (LED)	259.00	284.00	10/300
GF012027	20A 2 Way Switch	277.00	309.00	10/300
GF012028	25A 1 Way Switch	295.00	321.00	10/300

Code	Item	MRP ₹		Pkg.
		Absolute White	Titanium Silver Titanium Grey Stardust Grey	
32AMP DP SWITCHES 240V- [2 Module] GLINE				
GF012031	32A DP Switch with Indicator (LED)	413.00	454.00	10/300

Code	Item	MRP ₹		Pkg.
		Absolute White	Titanium Silver Titanium Grey Stardust Grey	
10AX SWITCHES 240V- [1 Module] ECHO NEW				
GF011451*	1 Way Switch	82.00	89.00	20/600
GF011452*	1 Way Switch with Indicator (LED)	146.00	164.00	20/600
GF011453*	2 Way Switch	166.00	183.00	20/600
GF011454*	Bell Push Switch	168.00	185.00	20/600
GF011455*	Bell Push Switch with Indicator (LED)	177.00	194.00	20/600

Code	Item	MRP ₹		Pkg.
		Absolute White	Titanium Silver Titanium Grey Stardust Grey	
10AX SWITCHES 240V- [2 Module] ECHO NEW				
GF012460*	1 Way Switch	144.00	158.00	10/300
GF012461*	1 Way Switch with Indicator (LED)	155.00	169.00	10/300
GF012462*	2 Way Switch	224.00	246.00	10/300
GF012463*	Bell Push Switch	224.00	246.00	10/300
GF012464*	Bell Push Switch with Indicator (LED)	247.00	272.00	10/300

Code	Item	MRP ₹		Pkg.
		Absolute White	Titanium Silver Titanium Grey Stardust Grey	
20AMP / 25AMP SWITCHES 240V- [1 Module] ECHO NEW				
GF011470*	20A 1 Way Switch	223.00	245.00	20/600
GF011471*	20A 1 Way Switch with Indicator (LED)	242.00	265.00	20/600
GF011472*	20A 2 Way Switch	247.00	271.00	20/600
GF011473*	25A 1 Way Switch	266.00	292.00	20/600

Code	Item	MRP ₹		Pkg.
		Absolute White	Titanium Silver Titanium Grey Stardust Grey	
20AMP / 25AMP SWITCHES 240V- [2 Module] ECHO NEW				
GF012475*	20A 1 Way Switch	244.00	267.00	10/300
GF012476*	20A 1 Way Switch with Indicator (LED)	272.00	298.00	10/300
GF012477*	20A 2 Way Switch	291.00	324.00	10/300
GF012478*	25A 1 Way Switch	310.00	337.00	10/300

Code	Item	MRP ₹		Pkg.
		Absolute White	Titanium Silver Titanium Grey Stardust Grey	
32AMP DP SWITCHES 240V- [2 Module] ECHO NEW				
GF012481*	32A DP Switch with Indicator (LED)	434.00	477.00	10/300

* introducing shortly





Code	Item	MRP ₹		Pkg.
		Absolute White	Titanium Silver Titanium Grey Stardust Grey	
10AX SWITCHES 240V- [1 Module] Style				
GF011601*	1 Way Switch	97.00	107.00	20/600
GF011602*	1 Way Switch with Indicator (LED)	177.00	194.00	20/600
GF011603*	2 Way Switch	177.00	194.00	20/600
GF011604*	Bell Push Switch	187.00	206.00	20/600
GF011605*	Bell Push Switch with Indicator (LED)	209.00	230.00	20/600

Code	Item	MRP ₹		Pkg.
		Absolute White	Titanium Silver Titanium Grey Stardust Grey	
10AX SWITCHES 240V- [2 Module] Style				
GF012610*	1 Way Switch	198.00	218.00	10/300
GF012611*	1 Way Switch with Indicator (LED)	220.00	242.00	10/300
GF012612*	2 Way Switch	231.00	254.00	10/300
GF012613*	Bell Push Switch	242.00	266.00	10/300
GF012614*	Bell Push Switch with Indicator (LED)	264.00	290.00	10/300

Code	Item	MRP ₹		Pkg.
		Absolute White	Titanium Silver Titanium Grey Stardust Grey	
20AMP / 25AMP SWITCHES 240V- [1 Module] Style				
GF011620*	20A 1 Way Switch	235.00	259.00	20/600
GF011621*	20A 1 Way Switch with Indicator (LED)	257.00	283.00	20/600
GF011622*	20A 2 Way Switch	263.00	294.00	20/600
GF011623*	25A 1 Way Switch	290.00	319.00	20/600

Code	Item	MRP ₹		Pkg.
		Absolute White	Titanium Silver Titanium Grey Stardust Grey	
20AMP / 25AMP SWITCHES 240V- [2 Module] Style				
GF012625*	20A 1 Way Switch	263.00	289.00	10/300
GF012626*	20A 1 Way Switch with Indicator (LED)	284.00	313.00	10/300
GF012627*	20A 2 Way Switch	284.00	313.00	10/300
GF012628*	25A 1 Way Switch	317.00	349.00	10/300

Code	Item	MRP ₹		Pkg.
		Absolute White	Titanium Silver Titanium Grey Stardust Grey	
32AMP DP SWITCHES 240V- [2 Module] Style				
GF012631*	32A DP Switch with Indicator (LED)	435.00	479.00	10/300

* introducing shortly

Code	Item	MRP ₹		Pkg.
		Absolute White	Titanium Silver Titanium Grey Stardust Grey	
6AMP SOCKETS 240V- [2 Module]				
GF012038	6A 3 Pin Socket with safety shutter	152.00	168.00	10/450

Code	Item	MRP ₹		Pkg.
		Absolute White	Titanium Silver Titanium Grey Stardust Grey	
6&16AMP SOCKETS 240V- [2 Module]				
GF012041	6&16A Universal Socket with safety shutter	301.00	330.00	10/450
GF012042	6&16A Universal Socket (Heavy Duty) with safety shutter	324.00	355.00	10/450
GF012044	6&16A Universal Socket with flap & Indicator (Suggested for without partition plate)	281.00	310.00	10/450

Code	Item	MRP ₹		Pkg.
		Absolute White	Titanium Silver Titanium Grey Stardust Grey	
DIMMER / FAN REGULATOR 240 V- [1 Module]				
GF011045	Dimmer - 240V 50-60Hz 300-450W	350.00	383.00	20/600
GF011048	Step Regulator - Full Rotary 4 Step, 240V 50-60 Hz	515.00	567.00	20/600
GF011049	Step Regulator - 4 Step, 240V 50-60 Hz	515.00	567.00	20/600

Code	Item	MRP ₹		Pkg.
		Absolute White	Titanium Silver Titanium Grey Stardust Grey	
GALAXY FAN REGULATOR 240V- [2 Module]				
GF012049	Fan Regulator - Full Rotary 8 Step, 240V 50-60 Hz	569.00	679.00	10/300
GF012050	Fan Regulator - Half Rotary	495.00	-	10/300
GF012051	Fan Regulator - Full Rotary	520.00	-	10/300
GF012052	Fan Regulator - Half Rotary (Chr. Knob)	-	599.00	10/300
GF012053	Fan Regulator - Full Rotary (Chr. Knob) 5 Step, 240V 50-60 Hz	-	629.00	10/300

Code	Item	MRP ₹		Pkg.
		Absolute White	Titanium Silver Titanium Grey Stardust Grey	
MOTOR STARTER (SP) 240V- 50-60Hz [2 Module]				
GF012061	25A Motor Starter Switch	689.00	757.00	10/300

Code	Item	MRP ₹		Pkg.
		Absolute White	Titanium Silver Titanium Grey Stardust Grey	
TV SOCKET / RJ-11 TELEPHONE JACKS / EDP SOCKET [1 Module]				
GF011066	TV Socket Coaxial 40-862 Mhz Socket	159.00	177.00	20/900
GF011068	Telephone Jack - RJ 11	169.00	186.00	20/600
GF011072	EDP Socket Outlet - RJ 45 (Cat 5e) Category 5e, Universal wiring T568A, insulating-piercing terminal	276.00	302.00	20/600
GF011074	EDP Socket Outlet - RJ 45 (Cat 6e) Category 6e, Universal wiring T568A, insulating-piercing terminal	701.00	771.00	20/600

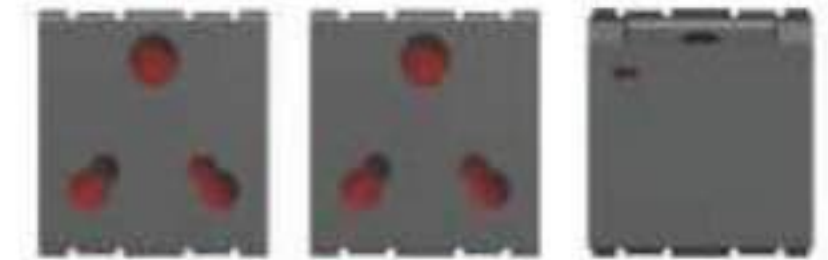
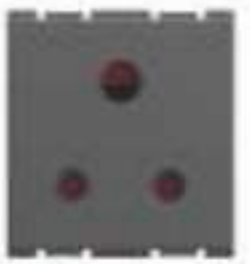

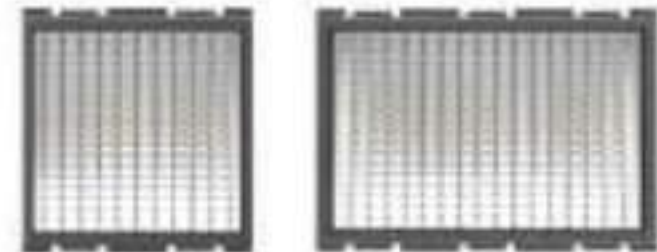

Code	Item	MRP ₹		Pkg.
		Absolute White	Titanium Silver Titanium Grey Stardust Grey	
AUDIO - VIDEO SOCKET [1 Module]				
GF011076	HDMI Socket	1050.00	1157.00	5/150
SINGLE POLE MCBS 240/450V~ [1 Module]				
GF011077	C6 SP MCB	365.00	415.00	20/600
GF011078	C10 SP MCB	365.00	415.00	20/600
GF011079	C16 SP MCB	365.00	415.00	20/600
GF011080	C20 SP MCB	365.00	415.00	20/600
GF011081	C25 SP MCB	365.00	415.00	20/600
GF011082	C32 SP MCB	365.00	415.00	20/600
	240/450V~ 50-60Hz 3.0kA Breaking Capacity			
DOUBLE POLE MCBS 240/450V~ [2 Module]				
GF012084	C6 DP MCB	717.00	789.00	10/300
GF012085	C10 DP MCB	717.00	789.00	10/300
GF012086	C16 DP MCB	717.00	789.00	10/300
GF012087	C20 DP MCB	717.00	789.00	10/300
GF012088	C25 DP MCB	717.00	789.00	10/300
GF012089	C32 DP MCB	717.00	789.00	10/300
	240/450V~ 50-60Hz 3.0kA Breaking Capacity			
INDICATOR / FUSE UNIT / BLANK MODULE [1 Module]				
GF011093	Indicator with LED & Red Diffuser	138.00	157.00	20/600
GF011098	Fuse Carrier (10Amp/16Amp) with miniature fuse dia 6.3x28	185.00	203.00	20/600
GF011125	Blank Module	33.00	36.00	50/2000
STEP MARKER				
GF012104	LED Step Marker (2M) Supply voltage 240V~ 50-60Hz	567.00	626.00	5/100
GF012105	i-Push Step Marker (2M) Supply voltage 240V~ 50-60Hz with high-efficiency 2x0.5W LED	1248.00	1373.00	5/100
GF013106	Step Marker (3M) Supply voltage 240V~ 50-60Hz with high-efficiency 2x0.5W LED	654.00	719.00	5/100
LIGHTING FITTING WITH EMERGENCY FUNCTION				
GF012110	Lighting Fitting with Emergency Function (2M) with High Efficiency 2x0.5W LED & 3 Steps	928.00	1021.00	5/100
GF013111	Lighting Fitting with Emergency Function (3M) with High Efficiency 3x0.5W LED & 3 Steps Dimming Switch 240V~ 50Hz when battery is inserted, the device will function as an emergency light - Battery not included (101124)	1370.00	1507.00	5/100

Code	Item	MRP ₹		Pkg.
		Absolute White	Titanium Silver Titanium Grey Stardust Grey	
ELECTRONIC BELL 240V~ [2 Module]				
GF012139	Electronic Bell 240V~50-60Hz	398.00	438.00	10/300
32A MAIN SWITCH [2 Module]				
GF012163	32A DP Operated by Key Tag 240V~, LED Supplied with Key Tag	663.00	729.00	10/300
GF012164	Only Key Tag with Name Plate	122.00	134.00	N.A.
25A ELECTRONIC BADGE SWITCH [3 Module]				
GF013165	Electronic Switch with Smart Card 25A 240V~ 50-60Hz with indicator (LED) & Integral relay having exit delay.	1737.00	1907.00	5/100
GF013166	Smart Card Customizable Smart Card	147.00	-	N.A.
DND/MAKE MY ROOM [2 Module]				
GF012168	Do Not Disturb/Make My Room 240V~ 50-60Hz - Inside Room	559.00	615.00	10/300
GF012169	Do Not Disturb/Make My Room 240V~ 50-60Hz - Outside Room	597.00	657.00	10/300
UNIVERSAL USB CHARGER 240V~				
GF012170	65W C-Type Fast Charger - Single Port (2M) Supply voltage 160-240V~ 50-60Hz Output - PD Charger C type (Max 65W)	NEW	-	5/100
GF011171	USB Fast Charger - Single Port (1M) Supply voltage 160-240V~ 50-60Hz Output - 5V=1.50A / 9V=1.45A, A type (Max 14W)	998.00	1097.00	20/600
GF012173	Dual Port USB Charger (2M) Supply voltage 160-240V~ 50-60Hz Output - 5V DC, 2000mA or 2A, A type	966.00	1063.00	5/100
GF013174	Dual Port USB Charger with Ind. & 10A International Socket (3M) Supply voltage 160-240V~ 50-60Hz Output - 5V DC, 2000mA or 2A, A type	1310.00	1439.00	5/100
GF011175	18W C-Type Fast Charger - Single Port (1M) Supply voltage 160-240V~ 50-60Hz Output - 5V=1.50A / 9V=1.45A	1350.00	1410.00	20/600
I-WAVE SWITCH 240V~ [2 Module]				
GF012201	I-Wave Switch Electronic Sensor switch Supply voltage 160-240V~ 6A relay output Allows to control lights by simply passing the hand in front of it (Max distance 50mm). Upto 5 Switches can be combined to control the same lighting circuit.	2999.00	3300.00	5/100





Code	Item	MRP ₹		Pkg.
		Absolute White	Titanium Silver Titanium Grey Stardust Grey	
i-TOUCH ZIGBEE 6A & 20A SWITCH [2 Module] NEW				
GF012901	i-Touch - Zigbee 2 Switch Supply voltage 160-240V-, 6A relay output Operating load (CFL & LED): 100W Max (per switch) Working Frequency : 2.4 GHz	-	-	5/100
GF012903	i-Touch - Zigbee 20A Switch Supply voltage 160-240V-, 20A relay output Operating load (CFL & LED): 200W Max Air conditioner: 2 ton Working Frequency : 2.4 Ghz Can also be operated by Goldmedal G-world app via Zigbee Gateway or Multimode Gateway	-	-	5/100
i-TOUCH ZIGBEE FAN REGULATOR [2 Module] NEW				
GF012907	i-Touch Zigbee Fan Regulator Supply voltage 160-240V- Variable Capacitance based 4 step regulator Operating load (Fan) : 100W Working Frequency : 2.4 Ghz Can also be operated by Goldmedal G-world app via Zigbee Gateway or Multimode Gateway	-	-	5/100
i-TOUCH ZIGBEE DRAPE CONTROLLER [2 Module] NEW				
GF012909	i-Touch Zigbee Drape Controller Supply voltage 160-240V- 2.5A relay output Electronic Drape Controller suitable for AC Motor Working Frequency : 2.4 Ghz Can also be operated by Goldmedal G-world app via Zigbee Gateway or Multimode Gateway	-	-	5/100
i-TOUCH ZIGBEE SWITCH [3 Module] NEW				
GF013913	i-Touch - Zigbee 4 Switch with Master Supply voltage 160-240V-, 6A relay output Operating load (CFL & LED): 100W Max (per switch) Working Frequency : 2.4 Ghz	-	-	5/100
GF013916	i-Touch - Zigbee 2 Switch + 1 Fan Regulator with Master Supply voltage 160-240V-, 6A relay output Operating load (CFL & LED): 100W Max (per switch) Working Frequency : 2.4 Ghz Can also be operated by Goldmedal G-world app via Zigbee Gateway or Multimode Gateway	-	-	5/100
i-TOUCH ZIGBEE PANEL 240V- [6 Module] NEW				
GF016925	i-Touch - Zigbee 6 Switch + Fan Reg. + Type C Port + Master (With Glass Plate) Supply voltage 160-240V-, 6A relay output Operating load (CFL & LED): 100W Max (per switch) Working Frequency : 2.4 GHz Variable Capacitance based 4 Step Fan Regulator USB Output: 65W PD type C Can also be operated by Goldmedal G-world app via Zigbee Gateway or Multimode Gateway	-	-	5/-

Code	Item	MRP ₹		Pkg.
		Absolute White	Titanium Silver Titanium Grey Stardust Grey	
SMART PASSIVE INFRARED DETECTOR [2 Module]				
GF012212	Smart Passive Infrared Detector with infrared sensor, auto on/off, adjustable dusk/dawn sensor threshold and time delay cycle, supply voltage 240V-50-60Hz 6A relay output	1872.00	2066.00	5/100
I - DOCK PLAYER [4 Module]				
GF014280	I-Dock Player Supply voltage 240V-, Inbuilt stereo amplifier : 2 x 4W, charging function for Iphone 5, 5S, 5C, 6, 6S, 6Plus, I-pod Touch & I-Pad Air, Gesture control for music & cell phone communication, SIRI enabled. Can be connected to any music system, home audio system, speakers i.e ceiling or inwall through amplifier via Line out (Aux out) Audio input - 3.5mm jack, I-pod, I-phone & Bluetooth Enable devices. Audio output - Stereo Line out, 2 Speaker out 4W each [Amplifier supplied separately - 101320 A Curve Modular Product] - (Page No. 36)	7100.00	7800.00	5/50
GALAXY DOCK PLAYER [4 Module]				
GF014281	Galaxy Dock Player Supply voltage 240V-, Inbuilt stereo amplifier : 2 x 4W, charging function for Samsung S2 and above compatible with charger. Gesture control for music & cell phone communication, S-Voice enabled. Can be connected to any music system, home audio system, speakers i.e ceiling or inwall through amplifier via Line out (Aux out) Audio input - 3.5mm jack, Android devices & Bluetooth Enable devices. Audio output - Stereo Line out, 2 Speaker out 4W each [Amplifier supplied separately - 101320 A Curve Modular Product] - (Page No. 36)	7100.00	7800.00	5/50
STEREOPHONIC SPEAKER [2 Module]				
GF012306	Stereophonic Speaker - 2 piece set Output : 3W Impedance : 4 ohms	1099.00	1199.00	10/100
ROUTER + EXTENDER [3 Module]				
GF013322	Wi-Fi Router + Extender 300 MBPS wi-fi wireless router with Ethernet port, Inbuilt USB port for internet connectivity and charging devices. Also support 4G dongle.	4500.00	5000.00	5/100

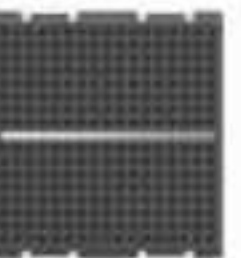
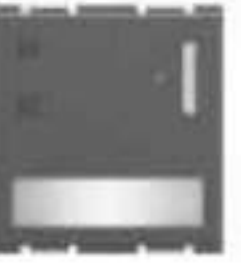



ZEN 2 Way Switch with Indicator (4 Gang)

ZEN

The Zen switch panels are aesthetically designed architectural switch systems that feature push-button switches along with other modular functionalities. With its intuitive design, high gloss finish, and versatile combinations, the Zen switch panels offer both style and convenience at your fingertips. Equipped with multifunctional sockets, USB slots, LEDs for visibility in the dark, and more, the Zen modules are perfect for modern homes, stylish offices, and upscale hospitality environments.



ZEN 2 International Sockets with 2 Switches & Dual USB Port (4M)

Code	Item	MRP ₹		Pkg. Outer/ Master
		Absolute White	Black Glass White Glass	
10AX / 20A SWITCHES 240V- (2 Module) ZEN				NEW
GF012501	20A 2 Way Switch with Indicator (1 Gang)	-	1100.00	-
GF012502	10AX 2 Way Switch with Indicator (2 Gang)	-	1450.00	-
GF012503	10AX 2 Way Switch with Indicator (3 Gang)	-	1750.00	-
GF012504	10AX 2 Way Switch with Indicator (4 Gang)	-	2150.00	-
10AX BELL PUSH SWITCH 240V- (2 Module) ZEN				NEW
GF012505	10AX Bell Push Switch with Indicator (1 Gang)	-	1050.00	-
32A DP SWITCH 240V- (2 Module) ZEN				NEW
GF012506	32A DP Switch with Indicator	-	1150.00	-
10A SOCKET 240V- ZEN				NEW
GF012507	10A International Socket with Switch (2M) Supply voltage 240V- 50-60Hz	-	1150.00	-
GF014508	10A 2 International Sockets with 2 Switches & Dual USB Port (4M) Supply voltage 160-240V- 50-60Hz USB Output - 5V DC, 2000mA or 2A, A type	-	3850.00	-





Gifa F9 Tom & Jerry Plate with Titanium Grey G-Line Switch

F9

The F9 range of modular plates are distinctly contemporary in styling. Represented by clear straight lines, crisp finish and imaginative use of colours, these cover plates showcase the very essential components of style. With a minimum of flourishes and embellishments, the F9 communicates the concept of a contemporary cover plate with remarkable clarity and power. Simple and elegant at first look, the F9 will steal your heart over a period of time.

Gifa F9 Dark Apricot Plate with Titanium Grey G-Line Switch, I-Push Step Marker



F9 COVER PLATES WITH MOUNTING FRAMES

PLATES →	1M	2M	3M	3M*	4M	4M*	6M	6M*	8M	8M*	8M	8M*	12M	12M*	16M*	18M
						(H&V)**		(H&V)**		(H&V)**	(V)	(H&V)		(H&V)**		
COLOURS ↓	MRP ₹	MRP ₹	MRP ₹	MRP ₹	MRP ₹	MRP ₹	MRP ₹	MRP ₹	MRP ₹	MRP ₹	MRP ₹	MRP ₹	MRP ₹	MRP ₹	MRP ₹	MRP ₹
Pure Glossy	118.00	118.00	145.00	145.00	177.00	177.00	263.00	253.00	334.00	322.00	334.00	322.00	381.00	367.00	415.00	486.00
Metallic	175.00	175.00	229.00	227.00	275.00	275.00	392.00	378.00	491.00	474.00	491.00	474.00	572.00	552.00	625.00	693.00
Wood	237.00	237.00	324.00	324.00	396.00	396.00	560.00	540.00	769.00	741.00	769.00	741.00	827.00	798.00	842.00	919.00

F9 BASIC COVER PLATES WITH MOUNTING FRAMES NEW

Pure Glossy	116.00	116.00	143.00	143.00	175.00	175.00	261.00	251.00	332.00	320.00	332.00	320.00	379.00	365.00	413.00	484.00
CODE →	GF30101	GF30201	GF30301	GF30303	GF30401	GF30403	GF30601	GF30603	GF30801	GF30803	GF38801	GF38803	GF31201	GF31203	GF31601	GF31801
Outer/Master →	10/400	10/400	10/300	10/300	10/300	10/300	5/150	5/150	5/150	5/150	5/150	5/150	5/120	5/120	5/90	5/80
SIZE(mm) →	98x91	98x91	121x91	121x91	146x91	152x91	220x91	220x91	245x90	275x90	152x168	152x168	220x157	220x157	245x157	220x222

* With Partition Plates ** Suitable for Horizontal & Vertical Installation

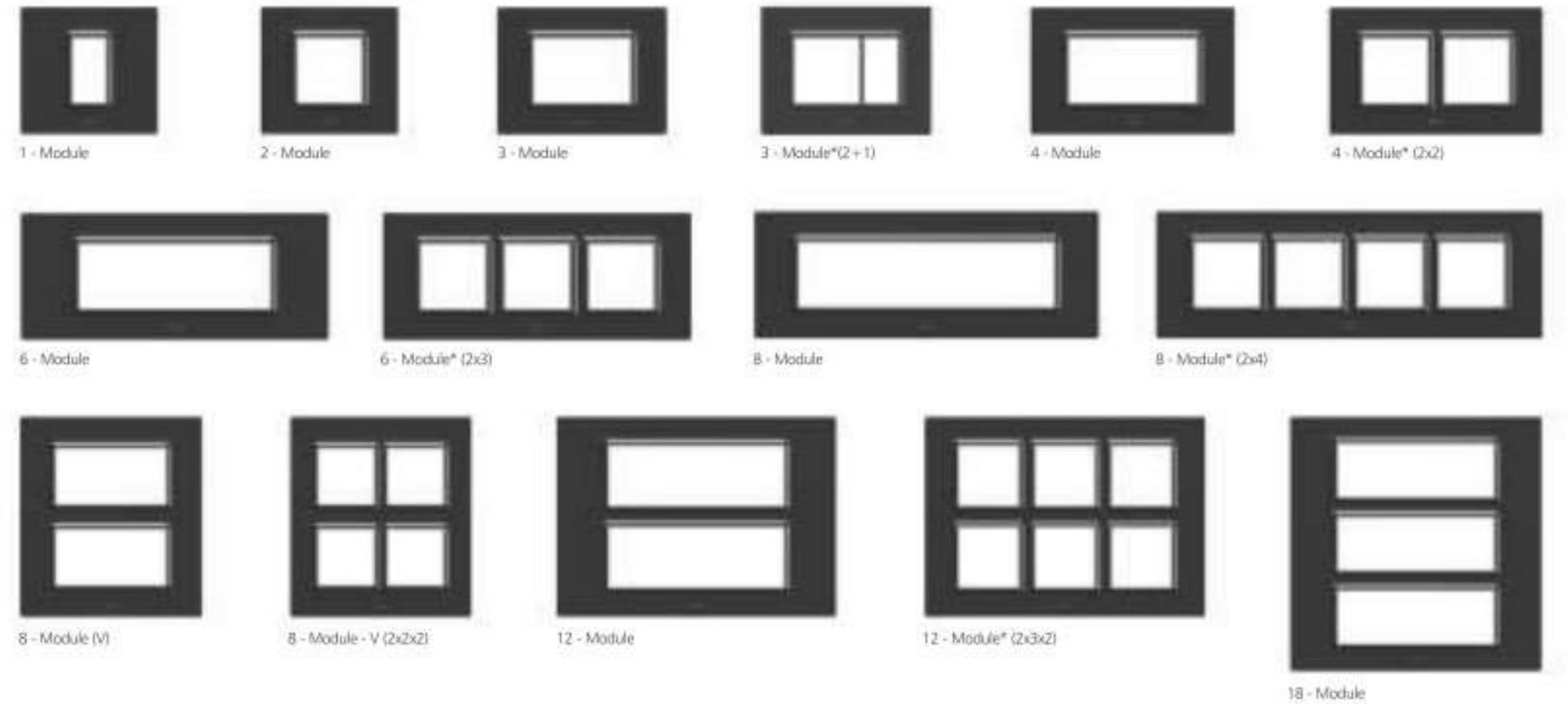

F9 MOUNTING FRAMES - Horizontal & Vertical Distance for Screwing (Dimensions in mm)

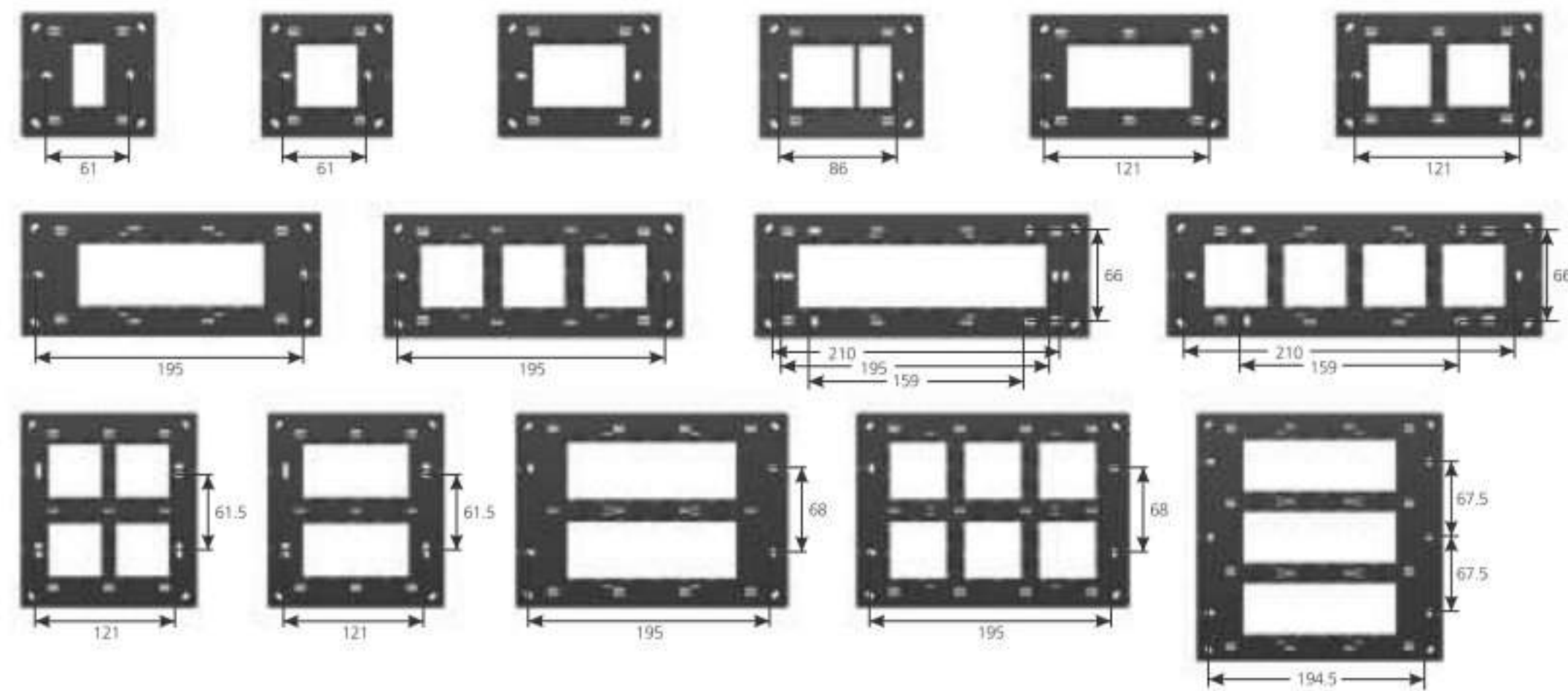



Gifa Ag Blue Sapphire Plate with Titanium Grey G-Line Switch, Regulator

A9

The colours of the A9 cover plates are modern yet delicate and almost ethereal in many ways. The tone is muted, relaxed and calm to ensure that these cover plates create a warm, welcoming environment around them. The choice of colours and texture allows the A9 cover plates to coexist peacefully with almost any type of ambience. Complement it with light interiors to create an air of purity and elegance or contrast it with dark interiors to create a rich, plush setting!

Gifa Ag French Wine Plate with Titanium Grey G-Line Switch, Emergency Light



A9 GLASS COVER PLATES										
A9 PLATES →	2M	3M	4M*	6M	6M*	8M*	8M (V)	12M	12M*	18M
			(H&V)**		(H&V)**	(H&V)**	(H&V)**		(H&V)**	
COLOURS ↓	MRP ₹	MRP ₹	MRP ₹	MRP ₹	MRP ₹	MRP ₹	MRP ₹	MRP ₹	MRP ₹	MRP ₹
Glass (diamond cut)	624.00	839.00	1216.00	1579.00	1676.00	1847.00	1847.00	1992.00	2113.00	2442.00
CODE →	GF50201	GF50301	GF50403	GF50601	GF50603	GF50803	GF58803	GF51201	GF51203	GF51801
Outer/Master →	10/200	10/200	10/150	5/100	5/100	5/100	5/100	5/75	5/75	5/40
SIZE(mm) →	108x94	130x94	154x94	228x94	228x94	280x94	156x173	228x160	228x160	228x228

* With Partition Plates ** Suitable for Horizontal & Vertical Installation

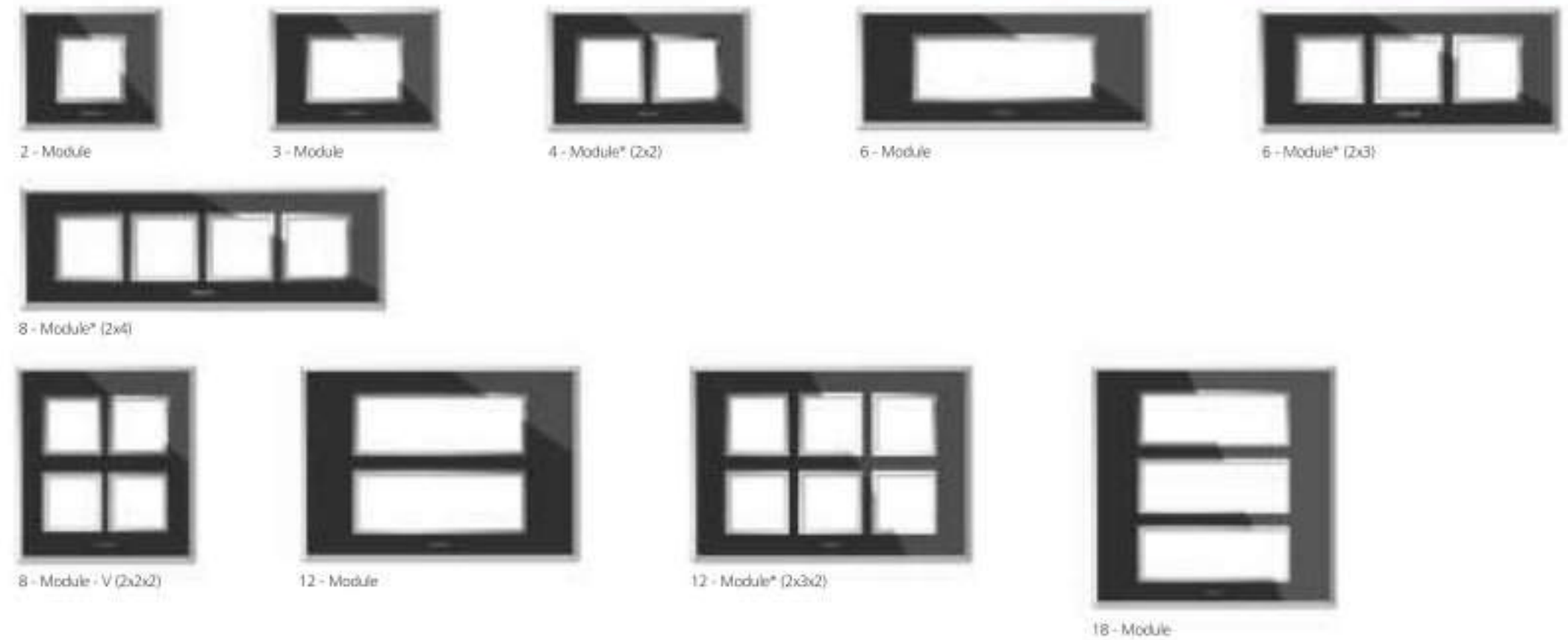

A9 MOUNTING FRAMES - Horizontal & Vertical Distance for Screwing [Dimensions in mm]										
A9 Frame →	2M	3M	4M	6M	6M	8M	8M (V)	12M	12M	18M
			(H&V)**		(H&V)**	(H&V)**	(H&V)**		(H&V)**	
MRP ₹ →	64.00	78.00	96.00	131.00	143.00	179.00	164.00	198.00	210.00	285.00
CODE →	GF50202	GF50302	GF50404	GF50602	GF50604	GF50804	GF58804	GF51202	GF51204	GF51802
Outer/Master →	25/750	25/750	25/500	20/240	20/240	20/240	20/240	20/160	20/160	10/80

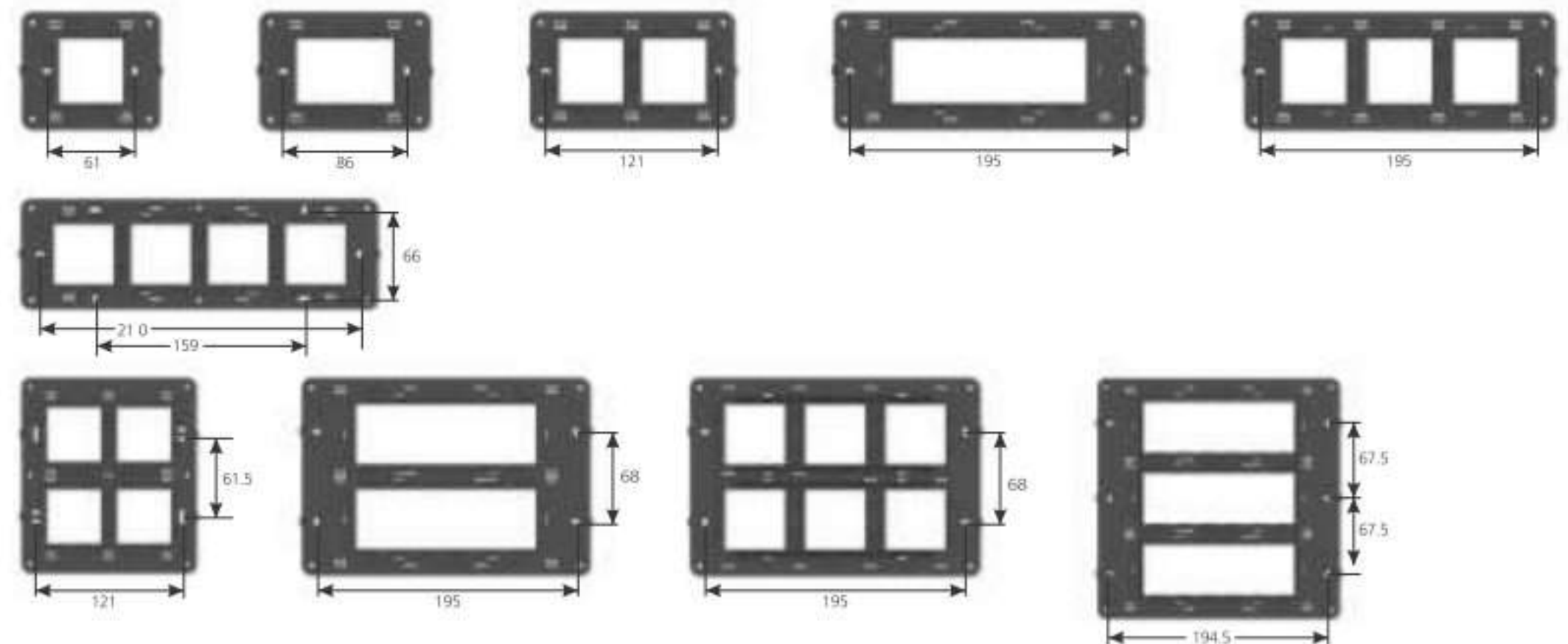



Gifa X9 Absolute White Plate with Titanium Grey C-Slide Switch, Regulator

X9

It's the cover plate with the X-factor. Shaped like an eye-catching curved TV, the X9 cover plate exhibits the aesthetics of an artistic centerpiece. Mount it on the wall and its curved shape lends this cover plate a floating look that appears ultra premium in any setting. Another unique feature is the raised chrome frame at the centre which elevates the design to a whole new level. Available in a variety of finishes, the X9 is a cover plate that's distinctly a cut above the rest.

Gifa X9 Absolute White Plate with Titanium Grey C-Slide Switch, Key Tag



X9 COVER PLATES WITH MOUNTING FRAMES

PLATES	2M	3M	4M	6M	8M	8M	12M	16M	18M
						(V)			
COLOURS	MRP ₹	MRP ₹	MRP ₹	MRP ₹	MRP ₹	MRP ₹	MRP ₹	MRP ₹	MRP ₹
Pure Glossy	141.00	188.00	223.00	324.00	382.00	353.00	488.00	571.00	676.00
Metallic	200.00	264.00	317.00	452.00	535.00	494.00	682.00	800.00	946.00
Wood	241.00	317.00	382.00	500.00	606.00	606.00	765.00	912.00	1088.00
CODE	GF60201	GF60301	GF60401	GF60601	GF60801	GF68801	GF61201	GF61601	GF61801
Outer/Master	10/400	10/300	10/300	5/150	5/150	5/150	5/120	5/90	5/80
SIZE(mm)	106x92	130x92	154x92	228x92	254x92	160x168	228x158	254x158	228x222

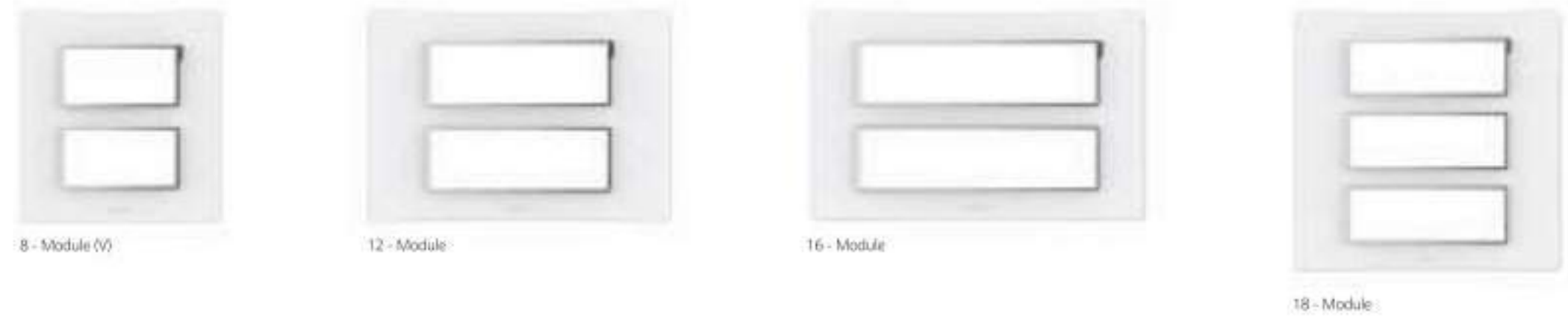

X9 MOUNTING FRAMES - Horizontal & Vertical Distance for Screwing (Dimensions in mm)

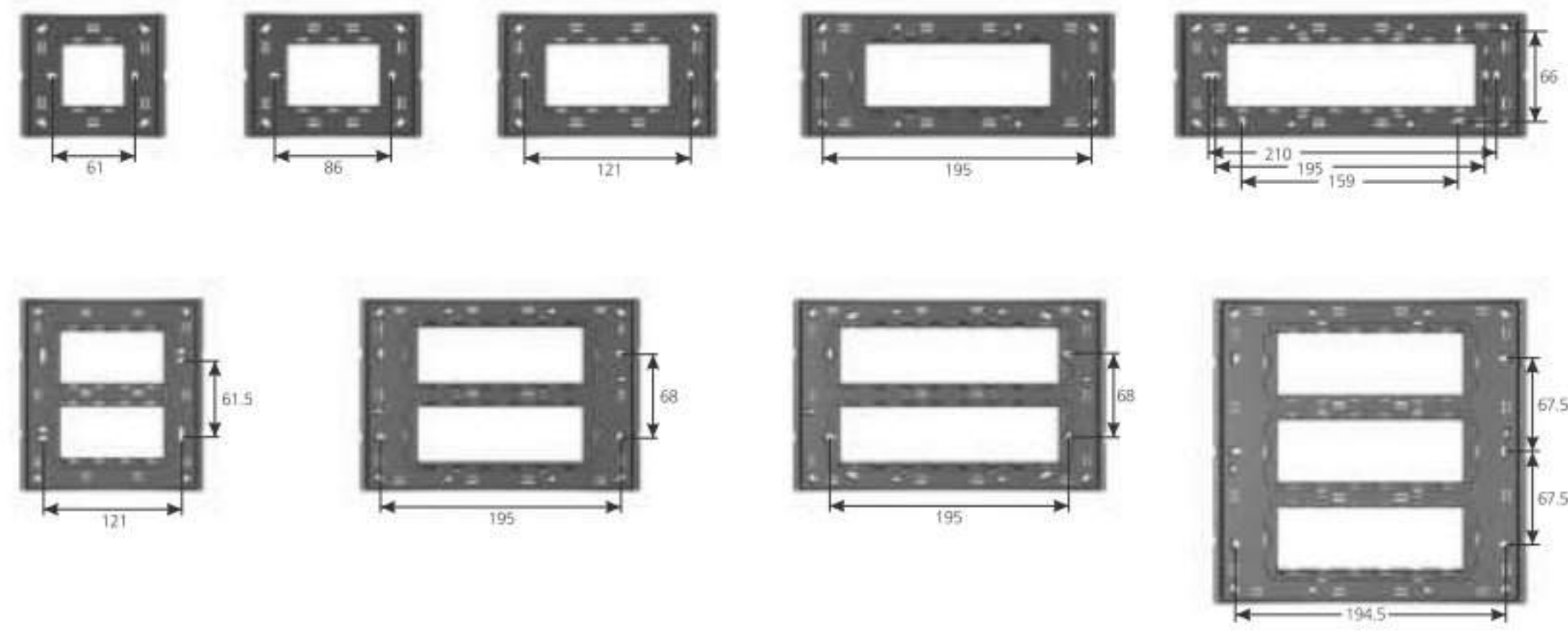

F9
PLATES

DEFINE YOUR WORLD WITH COLOURS

PURE GLOSSY



01 - Absolute White

METALLIC



06 - Titanium Silver



07 - Titanium Grey



08 - Champagne Gold



09 - Ferrari Red



10 - Atomic Blue



11 - Green Witch



12 - Nuclear Grey



13 - Purple Passion



14 - Red Fever



15 - Gaga Blue



16 - Lusty Ginger



17 - Puppy Brown

WOOD



01 - Fuzzy Brown



02 - Dark Apricot



03 - Chocolate Wood



04 - Tom & Jerry

X9
PLATES

DEFINE YOUR WORLD WITH COLOURS

PURE GLOSSY



01 - Absolute White

A9
GLASS PLATE



01 - Black Jack



*02 - Blue Witch



03 - French Wine



04 - Mountain Dew



05 - Frosty Blue



06 - Blue Sapphire



07 - Lusty Cherry



08 - Smoky Grey

* Introducing shortly

SAFETY IS A PROCESS.
IT STARTS WITH THE RIGHT PRODUCT.



i-Secure 18
WiFi Video Door Phone

Dimensions: 61x140x55 mm

Code : WFDA0001ALU
MRP ₹ : 13300.00
Pkg. : 1



i-Secure 09
7 Inch Analog door phone kit
in White

Dimensions: 196x132x20 mm (in-door)
Dimensions: 49x135x42 mm (out-door)

Code : VDPH0007WHIT
MRP ₹ : 15000.00
Pkg. : 1

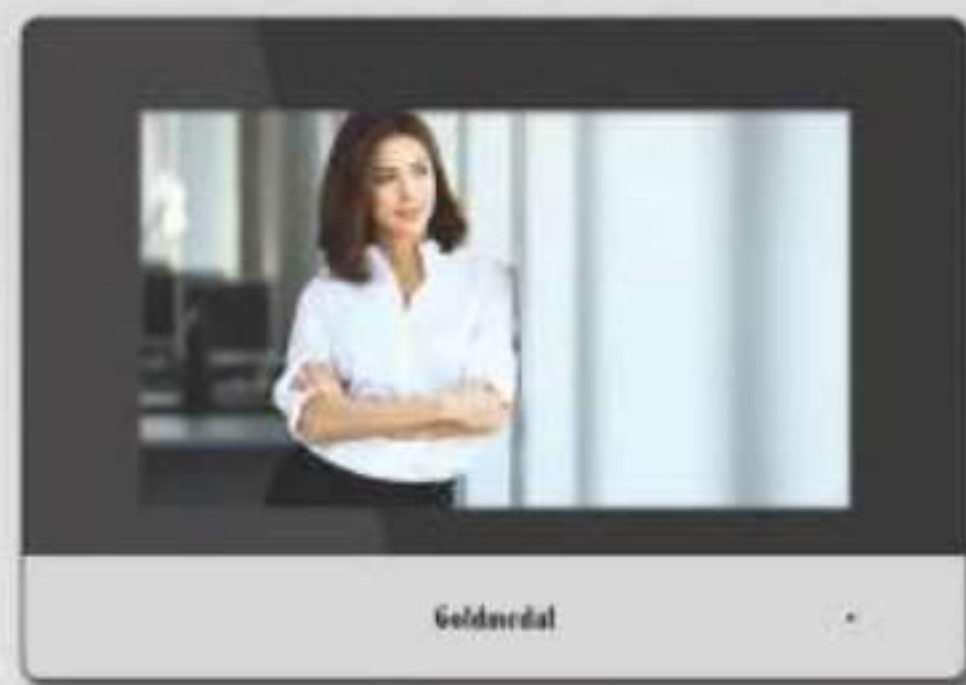

i-Secure 36
7 Inch IP video door phone kit
in Black

Dimensions: 199x139x23 mm (in-door)
Dimensions: 62x136x28 mm (out-door)

Code : VDIPH1007BLK
MRP ₹ : 34200.00
Pkg. : 1



i-Secure 07
7 Inch Analog door phone kit
in Silver

Dimensions: 214x150x18 mm (in-door)
Dimensions: 65x144x40 mm (out-door)

Code : VDPR1007SLR
MRP ₹ : 15000.00
Pkg. : 1

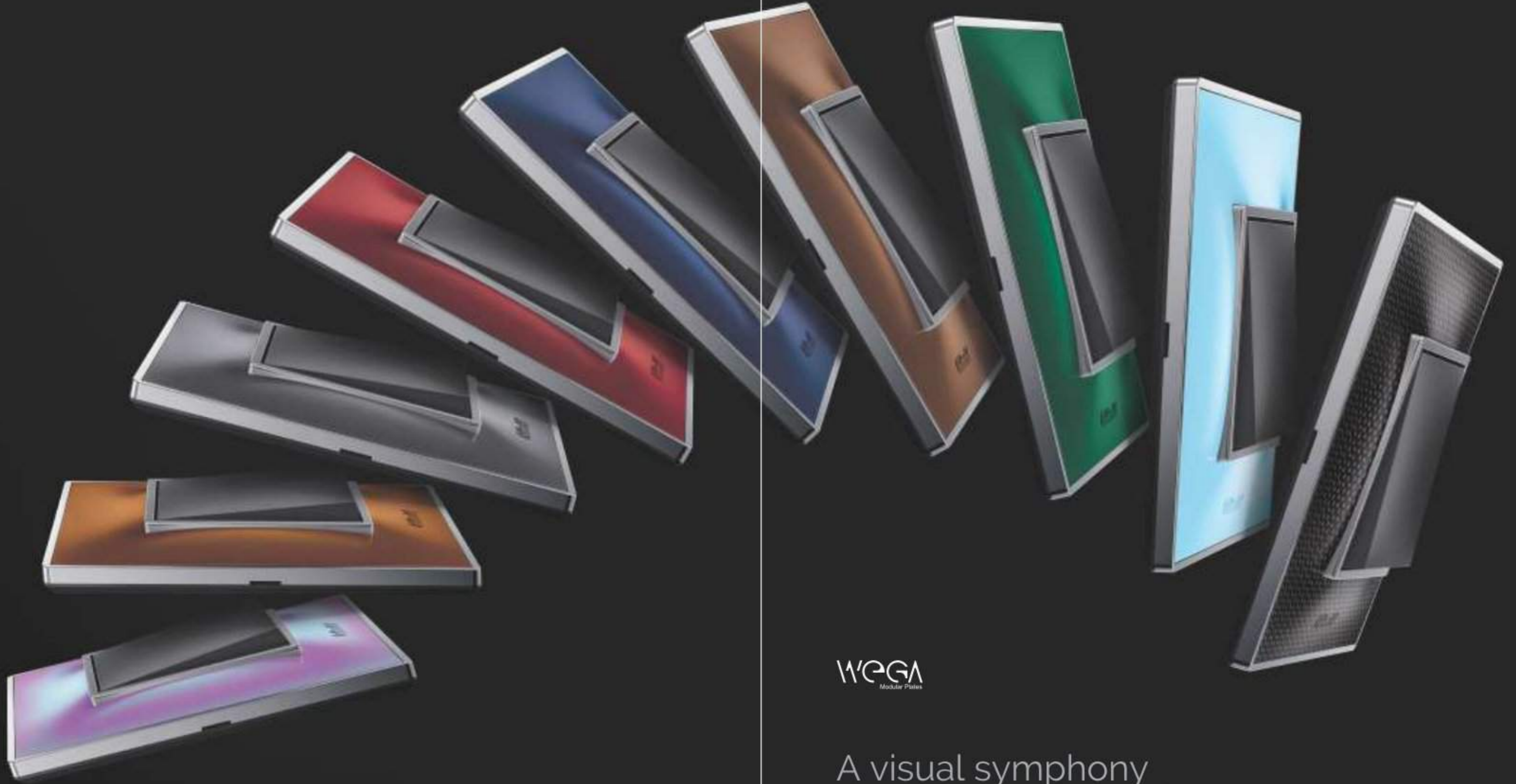

WEGA
Modular Plates

A visual symphony that elevates our existence.

Colours influence our everyday lives in ways we may not always realize. They surround us in every aspect of our lives, painting the world with a vibrant palette that evokes emotions, ignites imagination, and shapes our perceptions. It plays a pivotal role in human expressions and creations. They awaken a sense of wonder, reminding us of the awe-inspiring wonders that surround us. Therefore, let us fill our lives with the beauty of colours and create a life adorned with shades that make each moment more meaningful.

Endless possibilities for modern living

Nixon represents a new era in stylish living. Crafted in contemporary styles with minimalistic profiles in classical as well as revolutionary shades. Nixon introduces a variety of high quality lifestyle products that will change the way you look at modular switches and functions. All Nixon products are compatible with a variety of Goldmedal plates, including the Wega, making the possibilities for form, finish and colours, simply endless.



Wega Plate -
G-Dip Switch with Indicator



Wega Plate -
G-Click Switch with Indicator



Wega Plate -
i-Touch Wi-Fi Switches



Wega Plate -
i-Feel Fan Regulator



Wega Plate -
i-Sense Senso Switch



Wega Plate -
65W C Type Fast Charger



Wega Plate -
8 Step Full Rotary Fan Regulator



Wega Plate -
32A DP. Operated by Key Tag

Comfort & reliability built
on high-performance material.

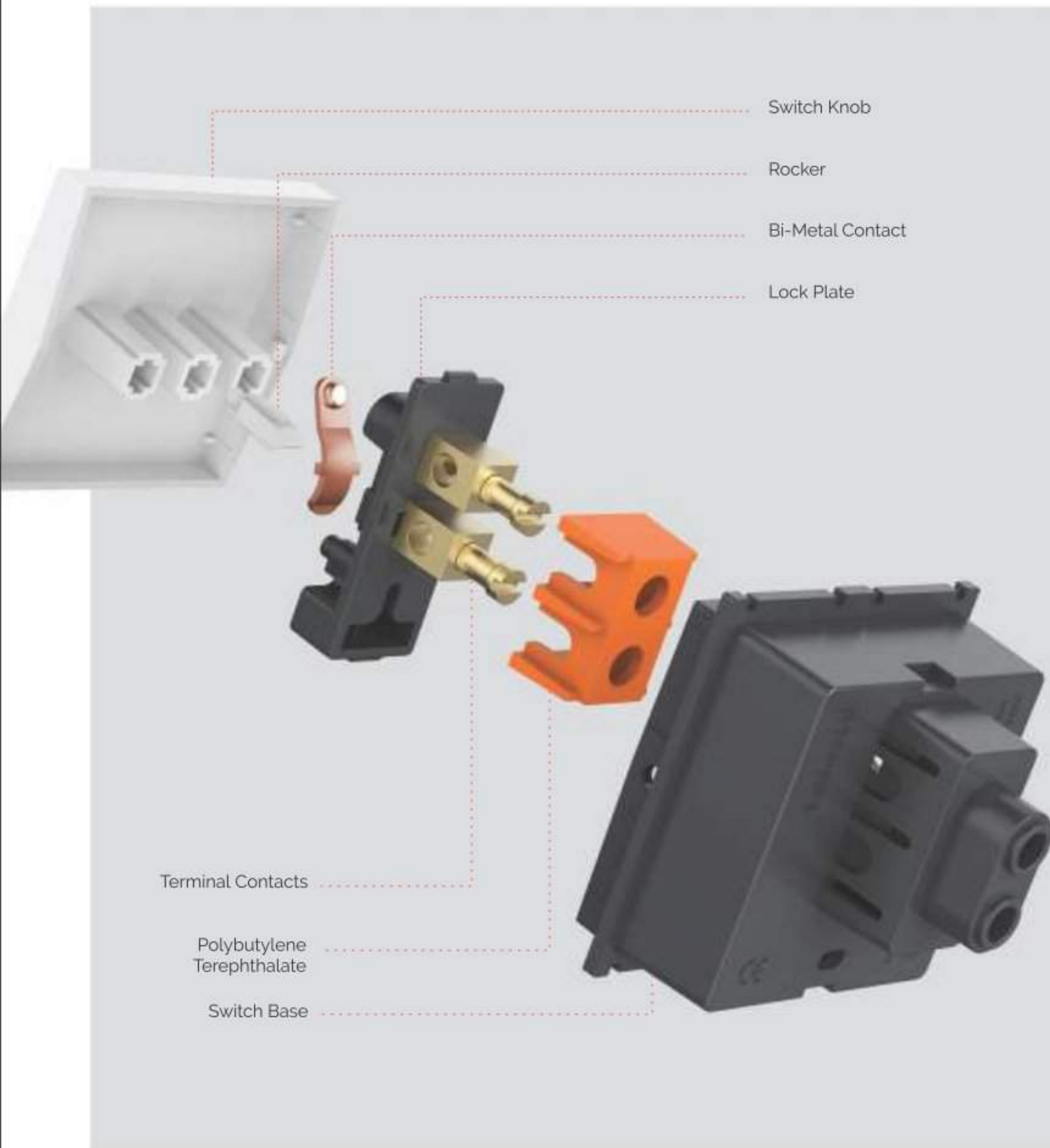

Polybutylene Terephthalate (PBT) Switches

Switches are superior quality electrical devices that are easy on the eye and extremely delightful to use. Making the smooth user experience possible is a combination of components that are precisely crafted from high-quality materials. The terminal contacts are supported by a casing of polybutylene terephthalate (PBT) within a PC base. With a high melting point above 200 degree Celsius, the PBT casing insulates every part of the switch from any electrical or thermal leakages. The thoughtful construction of the Goldmedal switches thus ensures greater reliability and increased durability over its long years of service.





Code	Item	MRP ₹		Pkg.
		White Jazz	Digital Chrome Voltage Grey	
10AX SWITCHES 240V~ (1 Module)				
101001	1 Way Switch	80.00	89.00	20/600
101002	1 Way Switch with Indicator (LED)	139.00	153.00	20/600
101003	2 Way Switch	160.00	176.00	20/600
101004	Bell Push Switch	163.00	181.00	20/600
101005	Bell Push Switch with Indicator (LED)	172.00	191.00	20/600
10AX SWITCHES 240V~ (2 Module)				
102010	1 Way Switch	138.00	150.00	10/300
102011	1 Way Switch with Indicator (LED)	149.00	165.00	10/300
102012	2 Way Switch	214.00	236.00	10/300
102013	Bell Push Switch	214.00	236.00	10/300
102014	Bell Push Switch with Indicator (LED)	239.00	262.00	10/300
6AMP BELL PUSH 240V~ (2 Module)				
102015	Bell Push with Luminous Name Plate 240V~ 50-60Hz LED circuit with diffuser	298.00	327.00	10/300
20AMP / 25 AMP SWITCHES 240V~ (1 Module)				
101020	20A 1 Way Switch	213.00	233.00	20/600
101021	20A 1 Way Switch with Indicator (LED)	230.00	253.00	20/600
101022	20A 2 Way Switch	236.00	260.00	20/600
101023	25A 1 Way Switch	256.00	282.00	20/600
20AMP / 25AMP SWITCHES 240V~ (2 Module)				
102025	20A 1 Way Switch	236.00	259.00	10/300
102026	20A 1 Way Switch with Indicator (LED)	259.00	284.00	10/300
102027	20A 2 Way Switch	273.00	300.00	10/300
102028	25A 1 Way Switch	297.00	326.00	10/300
32AMP DP SWITCHES 240V~				
102031	DP Switch with Indicator (LED) - 2M	402.00	442.00	10/300

Code	Item	MRP ₹		Pkg.
		White Jazz	Digital Chrome Voltage Grey	
6AMP SOCKETS 240V~				
102038	6A 3 Pin Socket (2M) with safety shutter	149.00	164.00	10/450
6&16AMP SOCKETS 240V~ (2 Module)				
102041	6&16A Universal Socket with safety shutter	293.00	323.00	10/450
102042	6&16A Universal Socket (Heavy Duty) with safety shutter	322.00	355.00	10/450
DIMMERS 240 V~50-60Hz 300-450W				
101045	Dimmer (1M) 450W	327.00	359.00	20/600
102046	Dimmer (2M) 450W	426.00	470.00	10/300
FAN REGULATOR 240V~				
102049	8 Step Reg. - Full Rotary (2M) NEW	570.00	622.00	10/300
101050	4 Step Regulator - Full Rotary (1M)	482.00	529.00	20/600
101051	4 Step Regulator (1M)	482.00	529.00	20/600
102052A	5 Step Regulator - Full Rotary (2M)	520.00	572.00	10/300
- Regulator Supplied in ISI & Non ISI				
MOTOR STARTER (SP) 240V~ 50-60Hz (2 Module)				
102059	25A Starter Switch	672.00	738.00	10/300
TV SOCKET / RJ-11 TELEPHONE JACKS (1 Module)				
101062	TV Socket Coaxial 40-862 Mhz Socket	163.00	179.00	20/900
101069	RJ-11 Single Telephone Jack	172.00	188.00	20/600





Code	Item	MRP ₹		Pkg.
		White Jazz	Digital Chrome Voltage Grey	
EDP SOCKET OUTLET RJ-45 WITH NAME PLATE (1 Module)				
101072	EDP Socket Outlet - RJ 45 (Cat 5e) Category 5e, Universal wiring T568A, insulating-piercing terminal with shutter	262.00	287.00	20/600
101074	EDP Socket Outlet - RJ 45 (Cat 6e) Category 6e, Universal wiring T568A, insulating-piercing terminal with shutter	691.00	759.00	20/600
SINGLE POLE MCBS 240/450V~ (1 Module)				
101077	C6 SP MCB	352.00	383.00	20/600
101078	C10 SP MCB	352.00	383.00	20/600
101079	C16 SP MCB	352.00	383.00	20/600
101080	C20 SP MCB	352.00	383.00	20/600
101081	C25 SP MCB	352.00	383.00	20/600
101082	C32 SP MCB 240/450V~ 50-60Hz 3kA Breaking Capacity	352.00	383.00	20/600
DOUBLE POLE MCBS 240/450V~ (2 Module)				
102083	C6 DP MCB	733.00	794.00	10/300
102084	C10 DP MCB	733.00	794.00	10/300
102085	C16 DP MCB	733.00	794.00	10/300
102086	C20 DP MCB	733.00	794.00	10/300
102087	C25 DP MCB	733.00	794.00	10/300
102088	C32 DP MCB 240/450V~ 50-60Hz 3kA Breaking Capacity	733.00	794.00	10/300
INDICATOR, FUSE UNITS (1 Module)				
101093	Indicator with LED & Red Diffuser	135.00	151.00	20/600
101098	Fuse Carrier 10 / 16AMP with miniature fuse dia 6.3x28	193.00	212.00	20/600
STEP MARKER LAMP (2 Module)				
102105	Step Marker Supply voltage 240V~ 50-60Hz with high-efficiency 1W LED & adjustable beam on three levels	604.00	664.00	5/120
FLOOR & STEP LIGHT 240~ (4 Module)				
120405	G-Focus Light (Blue LED)	814.00	895.00	5/120
120405W	G-Focus Light (White LED)	814.00	895.00	5/120
120405WW	G-Focus Light (Warm White LED)	814.00	895.00	5/120
120406	G-Focus Light Trio (LED) Fully recessed floor & step light with support frame & glassio cover plate with 3 color inbuilt LED Supply voltage 240V~50-60Hz	889.00	979.00	5/120

Code	Item	MRP ₹		Pkg.
		White Jazz	Digital Chrome Voltage Grey	
LIGHTING FITTING WITH EMERGENCY FUNCTION 240V~				
102119	Lighting Fitting with Emergency Function (2M) with High Efficiency 2x0.5W LED	933.00	1007.00	5/100
EMERGENCY LIGHT BATTERY				
101123	AAA Ni-MH 1.2V 1100 mAh without "memory" effect interchangeable - 3 Batteries set (Spare parts)	398.00	-	N.A.
101124	Battery Li-ion, 3.6V 600mAh 2/3A	261.00	-	20/600
BLANK MODULE (1 Module)				
101125	Blank Module	31.00	34.00	50/2000
ELECTRONIC BUZZERS (2 Module)				
102138	Electronic Cuckoo Buzzer 240V~ 50-60Hz (LED)	211.00	232.00	10/300
102139	Electronic Bell 240V~ 50-60Hz (LED)	362.00	399.00	10/300
25A ELECTRONIC BADGE SWITCH (3 Module)				
103165	Electronic Switch with Smart Card 25A, 160-240V~ 50-60Hz with indicator (LED) & Integral relay having exit delay.	1770.00	1943.00	5/100
103166	Smart Card Customizable Smart Card	134.00	-	N.A.
DND / MAKE MY ROOM (2 Module)				
102168A	Do Not Disturb/Make My Room 240V~ 50-60Hz - Outside Room	480.00	526.00	10/300
102169A	Do Not Disturb/Make My Room 240V~ 50-60Hz - Inside Room	516.00	565.00	10/300
SHAVER SOCKET (4 Module)				
104171	Shaver Socket 240V~ 50-60Hz with isolating transformer output 110/240V~	1099.00	1209.00	5/50

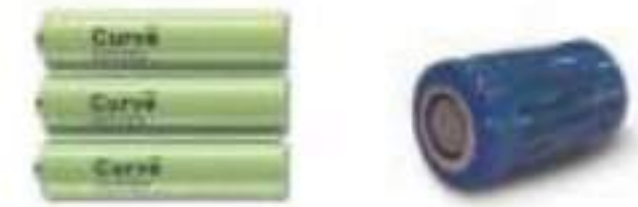



Code	Item	MRP ₹		Pkg.
		White Jazz	Digital Chrome Voltage Grey	
USB CHARGER 240V~				
102170	65W C-Type Fast Charger - Single Port (2M) Supply voltage 160-240V~ 50-60Hz Output - PD USB Charger C type (Max 65W)	-	-	5/100
101172	USB Fast Charger - Single Port (1M) Supply voltage 160-240V~ 50-60Hz Output - 5V=1.50A / 9V=1.45A, A type (Max 14W)	1017.00	1118.00	10/300
102174	USB Charger - Double Port (2M) Supply voltage 160-240V~ 50-60Hz Output - 5V DC, 2000mA or 2A, A type	984.00	1083.00	5/100
101175	18W C-Type Fast Charger - Single Port (1M) Supply voltage 160-240V~ 50-60Hz Output - 5V=1.50A / 9V=1.45A USB Charger C type (Max 18W)	1350.00	1410.00	10/300

CRISTALLO SWITCH MEMORIO KNOB				
101540	1 Module Switch Knob	12.00	-	50/2000
102541	2 Module Switch Knob	19.00	-	30/900
103542	3 Module Switch Knob (with support knob)	29.00	-	20/800

SMART PASSIVE INFRARED DETECTOR (2 Module)				
102212	Smart Passive Infrared Detector with infrared sensor, auto on/off, adjustable dusk/dawn sensor threshold and time delay cycle, supply voltage 240V~ 50-60Hz, 6A relay output	1819.00	1999.00	5/120

LPG / METANO GAS DETECTOR 240V~ (3 Module)				
103225	LPG / Metano Gas Detector Detector with acoustic and optical signaling and control on a solenoid valve, supply voltage 240V~50-60Hz	2599.00	2799.00	5/100

RF REMOTE (RADIO FREQUENCY)				
103268	RF Remote with Stand 2 Nos AAA 1.5V Battery Radio Frequency : 433.92 Mhz All scene setting can be done through the Remote. - Battery not included	-	1999.00	5/100

#please refer to page no. 67 for wiring diagram & technical details of Touch Switches.



Wega Titanium Grey Plate
with Digital Silver Wi-Fi Router+Extender

Working from home calls for a reliable Wi-Fi network. Goldmedal's Wi-Fi Router + Extender is a smart solution for dead zone problems that many face. This unique device not only ensures uninterrupted and consistent Wi-Fi connectivity but can also extend the network signal to the remotest corners of your home. The device also has an inbuilt USB port for charging devices and Ethernet port for Internet connectivity. On the subject of charging, you should also consider the USB Charger & International Socket for getting your smart devices and electrical appliances charged. Along with charging your mobile devices, it also accepts different types of international plugs.



Wega Titanium Grey Plate
with Digital Silver USB Charger & Inter. Socket



Code	Item	MRP ₹		Pkg.
		White Jazz	Digital Chrome Voltage Grey	
BLUETOOTH PLAYER [2 Module]				
102273	Bluetooth Player Supply voltage 240V- Bluetooth player with transmitter & receiver. Multicolour LED to display different status Audio input - 3.5mm jack, Bluetooth (Rx mode) Audio output - Can be connected to bluetooth speaker or headphones in Tx mode (Input - Aux in) - Can be connected to any music system, home audio system, speakers i.e ceiling or inwall through amplifier via Line out Amplifier supplied separately - 101320	1200.00	1300.00	5/100
BLUETOOTH & FM PLAYER [8 Module]				
108274	Bluetooth & FM Player with Speaker Supply voltage 240V- Mode selection -Aux (Line 1), Aux (Line 2), FM & Bluetooth. Audio input - 3.5 jack (Front), Line In (Back), Bluetooth Audio output - Inbuilt Stereophonic Speaker 3W x 2 - Can be connected to any music system, home audio system, speakers i.e ceiling or inwall through amplifier via Line out Amplifier supplied separately - 101320	4999.00	5499.00	5/50
i - DOCK PLAYER [4 Module]				
104281	i-Dock Player Supply voltage 240V- Inbuilt stereo amplifier : 2 x 4W, charging function for iPod and iPhone. Audio input - 3.5mm jack, i-pod, i-phone & via Bluetooth Receiver (101283) Audio output - Stereo Line out, 2 Speaker out 4W each - Can be connected to any music system, home audio system, speakers i.e ceiling or inwall through amplifier via Line out (Aux out) - Amplifier supplied separately - 101320 - Bluetooth Receiver supplied separately - 101283 Unit supplied with infrared Remote	3100.00	3300.00	5/50
BLUETOOTH RECEIVER [PORTABLE]				
101283	Bluetooth Receiver [Portable] Made for iPod and iPhone docking Can be operated by any bluetooth device i.e. iPod, iPhone, iPad, Laptop, Mobile etc.	-	1100.00	5/50

* introducing shortly

Code	Item	MRP ₹		Pkg.
		White Jazz	Digital Chrome Voltage Grey	
STEREOPHONIC SPEAKER [2 Module]				
102306	Stereophonic Speaker - 2 piece set Stereophonic loud Speaker Load rating : 4W Impedance : 4 ohms	699.00	769.00	10/100
CURVE MODULAR COVER PLATE SUITCASE				
101645*	Curve Cover Plate Suitcase	-	2100.00	1/5
AUTOMATION SUITCASE				
101649*	Automation Suitcase Quorra Crystallight plate with Nixon WiFi inserts RF remote 6M WiFi panel.	-	15000.00	1/5
GIFA MODULAR COVER PLATE SUITCASE				
101650*	Gifa Cover Plate Suitcase	-	3100.00	1/5



Note: Prices of above Suitcases are Net Price & will be billed in Project Only.

Smart living made
smarter.

i-Touch WiFi Panels

Feather Touch IoT/RF Enabled Home Automation



TOUCH



TAP



SWIPE



i-World



IOT



Scene Setting



Timer



Remote

Presenting the next step in smart living. The i-Touch WiFi panels are the latest devices in Goldmedal's family of automation switches. Sleek and stylish in appearance, these backlit LED WiFi panels have a host of functions including switches, fan regulators, dimmers, USB sockets, and international sockets. Apart from manual operations, you can also control these panels using the RF Remote control and voice commands. You can even operate these panels from anywhere in the world using the i-World mobile app. There's no gateway required - the technology is built into the device. A complete system by itself, the module can be installed directly into a regular junction without the need for any new wiring.



Code	Item	MRP ₹		Pkg.
		Absolute White	Digital Silver Titanium Grey	
10AX SWITCHES 240V- (1 Module)				
101401	1 Way Switch	81.00	88.00	20/600
101402	1 Way Switch with Indicator (LED)	143.00	157.00	20/600
101403	2 Way Switch	162.00	179.00	20/600
101404	Bell Push Switch	165.00	180.00	20/600
101405	Bell Push Switch with Indicator (LED)	174.00	190.00	20/600

Code	Item	MRP ₹		Pkg.
		Absolute White	Digital Silver Titanium Grey	
10AX SWITCHES 240V- (2 Module)				
102410	1 Way Switch	144.00	158.00	10/300
102411	1 Way Switch with Indicator (LED)	156.00	170.00	10/300
102412	2 Way Switch	224.00	245.00	10/300
102413	Bell Push Switch	224.00	245.00	10/300
102414	Bell Push Switch with Indicator (LED)	249.00	273.00	10/300
102415	Bell Push Switch with Luminous Name Plate	310.00	342.00	10/300

Code	Item	MRP ₹		Pkg.
		Absolute White	Digital Silver Titanium Grey	
20AMP / 25AMP SWITCHES 240V- (1 Module)				
101420	20A 1 Way Switch	217.00	239.00	20/600
101421	20A 1 Way Switch with Indicator	235.00	261.00	20/600
101422	20A 2 Way Switch	242.00	267.00	20/600
101423	25A 1 Way Switch	259.00	286.00	20/600

Code	Item	MRP ₹		Pkg.
		Absolute White	Digital Silver Titanium Grey	
20AMP / 25AMP SWITCHES 240V- (2 Module)				
102425	20A 1 Way Switch	240.00	263.00	10/300
102426	20A 1 Way Switch with Ind. (LED)	267.00	294.00	10/300
102427	20A 2 Way Switch	287.00	318.00	10/300
102428	25A 1 Way Switch	305.00	336.00	10/300

Code	Item	MRP ₹		Pkg.
		Absolute White	Digital Silver Titanium Grey	
32AMP DP SWITCHES 240V- (2 Module)				
102431	32A DP Switch with Indicator (LED)	423.00	467.00	10/300

240V- 50-60Hz LED circuit with diffuser

Code	Item	MRP ₹		Pkg.
		Absolute White	Digital Silver Titanium Grey	
G-Click 10AX SWITCHES 240V- (1 Module)				
101751	1 Way Switch	88.00	96.00	20/600
101752	1 Way Switch with Indicator (LED)	149.00	166.00	20/600
101753	2 Way Switch	165.00	182.00	20/600
101754	Bell Push Switch	172.00	187.00	20/600
101755	Bell Push Switch with Indicator (LED)	183.00	201.00	20/600

Code	Item	MRP ₹		Pkg.
		Absolute White	Digital Silver Titanium Grey	
G-Click 10AX SWITCHES 240V- (2 Module)				
102760	1 Way Switch	152.00	168.00	10/300
102761	1 Way Switch with Indicator (LED)	164.00	179.00	10/300
102762	2 Way Switch	234.00	256.00	10/300
102764	Bell Push Switch with Indicator (LED)	259.00	284.00	10/300

Code	Item	MRP ₹		Pkg.
		Absolute White	Digital Silver Titanium Grey	
G-Click 20AMP / 25AMP SWITCHES 240V- (1 Module)				
101770	20A 1 Way Switch	226.00	249.00	20/600
101771	20A 1 Way Switch with Indicator	237.00	261.00	20/600
101772	20A 2 Way Switch	243.00	267.00	20/600
101773	25A 1 Way Switch	271.00	298.00	20/600

Code	Item	MRP ₹		Pkg.
		Absolute White	Digital Silver Titanium Grey	
G-Click 20AMP / 25AMP SWITCHES 240V- (2 Module)				
102775	20A 1 Way Switch	251.00	276.00	10/300
102776	20A 1 Way Switch with Ind. (LED)	278.00	306.00	10/300
102777	20A 2 Way Switch	301.00	331.00	10/300
102778	25A 1 Way Switch	320.00	352.00	10/300

Code	Item	MRP ₹		Pkg.
		Absolute White	Digital Silver Titanium Grey	
G-Click 32AMP DP SWITCHES 240V- (2 Module)				
102781	32A DP Switch with Indicator (LED)	443.00	488.00	10/300





Code	Item	MRP ₹		Pkg.
		Absolute White	Digital Silver Titanium Grey	
G-Dip 10AX SWITCHES 240V- [1 Module] NEW				
101801*	1 Way Switch	81.00	88.00	20/600
101802*	1 Way Switch with Indicator (LED)	143.00	157.00	20/600
101803*	2 Way Switch	162.00	179.00	20/600
101804*	Bell Push Switch	165.00	180.00	20/600
101805*	Bell Push Switch with Indicator (LED)	175.00	193.00	20/600

Code	Item	MRP ₹		Pkg.
		Absolute White	Digital Silver Titanium Grey	
G-Dip 10AX SWITCHES 240V- [2 Module] NEW				
102810*	1 Way Switch	144.00	159.00	10/300
102811*	1 Way Switch with Indicator (LED)	156.00	170.00	10/300
102812*	2 Way Switch	224.00	245.00	10/300
102813*	Bell Push Switch	224.00	245.00	10/300
102814*	Bell Push Switch with Indicator (LED)	249.00	273.00	10/300

Code	Item	MRP ₹		Pkg.
		Absolute White	Digital Silver Titanium Grey	
G-Dip 20AMP / 25AMP SWITCHES 240V- [1 Module] NEW				
101820*	20A 1 Way Switch	217.00	239.00	20/600
101821*	20A 1 Way Switch with Indicator	235.00	261.00	20/600
101822*	20A 2 Way Switch	242.00	267.00	20/600
101823*	25A 1 Way Switch	259.00	286.00	20/600

Code	Item	MRP ₹		Pkg.
		Absolute White	Digital Silver Titanium Grey	
G-Dip 20AMP / 25AMP SWITCHES 240V- [2 Module] NEW				
102825*	20A 1 Way Switch	240.00	263.00	10/300
102826*	20A 1 Way Switch with Ind. (LED)	267.00	294.00	10/300
102827*	20A 2 Way Switch	287.00	318.00	10/300
102828*	25A 1 Way Switch	305.00	336.00	10/300

Code	Item	MRP ₹		Pkg.
		Absolute White	Digital Silver Titanium Grey	
G-Dip 32AMP DP SWITCHES 240V- [2 Module] NEW				
102831*	32A DP Switch with Indicator (LED)	423.00	467.00	10/300

Code	Item	MRP ₹		Pkg.
		Absolute White	Digital Silver Titanium Grey	
6AMP SOCKETS 240V-				

102438	6A 3 Pin Socket (2M) with safety shutter	157.00	172.00	10/450
--------	--	--------	--------	--------

6&16AMP SOCKETS 240V- [2 Module]				
---	--	--	--	--

102441	6&16A Universal Socket with safety shutter	308.00	339.00	10/450
102442	6&16A Universal Socket (Heavy Duty) with safety shutter	332.00	365.00	10/450

6 & 16AMP SOCKET WITH FLAP - [2 Module]				
--	--	--	--	--

102444	6&16A Universal Socket with flap & Indicator - 240V- (Suggested for without partition plate)	297.00	327.00	10/450
--------	---	--------	--------	--------

DIMMER / FAN REGULATOR 240 V-				
--------------------------------------	--	--	--	--

101445	Dimmer - 450W (1M)	362.00	397.00	20/600
102449	8 Step Regulator (2M) NEW	617.00	672.00	10/300
101450	4 Step Regulator - Full Rotary (1M)	531.00	585.00	20/600
101451	4 Step Regulator (1M)	531.00	585.00	20/600
102452	5 Step Regulator (2M)	567.00	622.00	10/300

- Regulator Supplied with ISI & Non ISI

FAN REGULATOR 240V- [2 Module]				
---	--	--	--	--

102453	5 Step Galaxy Step Regulator Half Rotary (Pure White)	522.00	-	10/300
102454	5 Step Galaxy Step Regulator Full Rotary (Pure White)	567.00	-	10/300

- Regulator Supplied with ISI & Non ISI

FAN REGULATOR 240V- [2 Module]				
---	--	--	--	--

102453A	5 Step Galaxy Step Regulator Half Rotary (Chrome Knob)	546.00	600.00	10/300
102454A	5 Step Galaxy Step Regulator Full Rotary (Chrome Knob)	592.00	651.00	10/300

- Regulator Supplied with ISI & Non ISI





Code	Item	MRP ₹		Pkg.
		Absolute White	Digital Silver Titanium Grey	
MOTOR STARTER (SP) 240V- 50-60Hz (2 Module)				
102459	25A Motor Starter Switch	706.00	776.00	10/300
TV SOCKET / RJ-11 TELEPHONE JACKS / EDP SOCKET (1 Module)				
101462	TV Socket Coaxial 40-862 Mhz Socket	165.00	179.00	20/900
101468	Telephone Jack - RJ 11	173.00	190.00	20/600
101472	EDP Socket Outlet - RJ 45 (Cat 5e) Category 5e, Universal wiring T568A, insulating-piercing terminal	282.00	311.00	20/600
101474	EDP Socket Outlet - RJ 45 (Cat 6e) Category 6e, Universal wiring T568A, insulating-piercing terminal	718.00	790.00	20/600
SINGLE POLE MCBS 240/450V- (1 Module)				
101477	C6 SP MCB	374.00	411.00	20/600
101478	C10 SP MCB	374.00	411.00	20/600
101479	C16 SP MCB	374.00	411.00	20/600
101480	C20 SP MCB	374.00	411.00	20/600
101481	C25 SP MCB	374.00	411.00	20/600
101482	C32 SP MCB 240/450V- 50-60Hz 3kA Breaking Capacity	374.00	411.00	20/600
DOUBLE POLE MCBS 240/450V- (2 Module)				
102483	C6 DP MCB	734.00	806.00	10/300
102484	C10 DP MCB	734.00	806.00	10/300
102485	C16 DP MCB	734.00	806.00	10/300
102486	C20 DP MCB	734.00	806.00	10/300
102487	C25 DP MCB	734.00	806.00	10/300
102488	C32 DP MCB 240/450V- 50-60Hz 3kA Breaking Capacity	734.00	806.00	10/300
G-POWER 16A UNIT (4 Module)				
104491A	G-Power 16A AC (Metal Box) Heavy Duty with Concealed Metal Junction Box (4M Plate with 32A MCB, 16A Socket & 16A G-grip Top)	881.00	975.00	5/60
104492A	G-Power 16A AC (Plastic Box) Heavy Duty with G-surface Plastic Gang Box (4M Plate with 32A MCB, 16A Socket & 16A G-grip Top) 240/450V- 50-60Hz 3kA Breaking Capacity	849.00	933.00	5/60
INDICATOR / FUSE UNIT / BLANK MODULE (1 Module)				
101493	Indicator with LED & Red Diffuser	141.00	155.00	20/600
101495	Indicator with LED & Red Diffuser (PCB)	141.00	155.00	20/600
101498	Fuse Carrier (10Amp/16Amp) with miniature fuse dia 6.3x28	190.00	208.00	20/600
101525	Blank Module	33.00	35.00	50/2000

Code	Item	MRP ₹		Pkg.
		Absolute White	Digital Silver Titanium Grey	
STEP MARKER				
102505	Step Marker (2M) with High Efficiency 2x0.5W LED	615.00	677.00	5/120
103506	Step Marker with Step Dimming Function (3M) with High Efficiency 3x0.5W LED	1132.00	1245.00	5/100
102507	Step Marker with Smart Dimming Function (2M) with High Efficiency 2x0.5W LED	856.00	940.00	5/100
103508	Step Marker with Trio LED & Step Dimming Function (3M) with High Efficiency 3x0.5W LED Supply voltage 240V- 50-60Hz,	1132.00	1245.00	5/100
LIGHTING FITTING WITH EMERGENCY FUNCTION				
102510	Lighting Fitting with Emergency Function (2M) with High Efficiency 2x0.5W LED	916.00	988.00	5/100
103511	Lighting Fitting with Emergency Function (3M) with High Efficiency 3x0.5W LED Supply voltage 160-240V- 50Hz Dimmable function (3 Level) The device will function as an emergency light if battery is inserted - Battery supplied separately (101123 for 3M / 101124 for 2M)	1444.00	1591.00	5/100
ELECTRO MECHANICAL BUZZER / ELECTRONIC BUZZER 240V -				
101530	Electro Mechanical Buzzer (1M) 240V-50-60Hz	185.00	203.00	20/600
102539	Electronic Bell (2M) 240V-50-60Hz	419.00	460.00	10/300
ELECTRONIC DOOR BELLS (4 Module) NEW				
104541	Electronic Multi Tune Bell with 4 selectable melodies Supply voltage 240V- 50-60Hz,	1086.00	1208.00	5/150
i-TOUCH RF SWITCHES / UNIVERSAL SWITCH (2 Module)				
102544	i-Touch 2 Switch Supply voltage 160-240V-, 6A relay output Operating load (ICFL & LED): 100W Max (per switch) Radio Frequency : 433.92 Mhz Can also be operated by RF Remote control-103268 or web/mobile application via Gateway-101646	3500.00	3900.00	5/100
102545	i-Touch Universal Switch Supply voltage 240V-, - Can be paired wirelessly with any Goldmedal RF switch, fan regulator, dimmer etc. (Touch, i-Touch and i-Feel) as a two way switch - Can be configured as a switch for any particular scene or All ON or All OFF command	3900.00	4300.00	5/100
i-TOUCH BELL PUSH / RF 20A SWITCH (2 Module)				
102548	i-Touch Bell Push Switch Supply voltage 160-240V- 2A relay output	2300.00	2500.00	5/100
102550	i-Touch 20A Switch Supply voltage 160-240V-, 20A relay output Operating load (ICFL & LED): 200W Max Air conditioner: 2 ton Radio Frequency : 433.92 Mhz Can also be operated by RF Remote control-103268 or web/mobile application via Gateway-101646	3600.00	4000.00	5/100





Code	Item	MRP ₹		Pkg.
		Absolute White	Digital Silver Titanium Grey	
i-TOUCH RF DIMMER/FAN REGULATOR/DRAPE CONTROLLER (2M)				
102553	i-Touch Light Dimmer Supply voltage 160-240V~, Triac Technology with soft end & soft start function Operating load (LED) : 80W (Max) Incandescent Light: 40-450W <i>Not suitable for Fan</i>	3500.00	3800.00	5/100
102554	i-Touch Fan Regulator Supply voltage 160-240V~ Variable Capacitance based 4 step regulator Operating load (Fan) : 100W	3500.00	3800.00	5/100
102556	i-Touch Drape Controller Supply voltage 160-240V~ 2.5A relay output Electronic RF Drape Controller suitable for AC Motor Radio Frequency : 433.92 Mhz Can also be operated by RF Remote control-103268 or web/mobile application via Gateway-101646	3800.00	4200.00	5/100

i-TOUCH DO NOT DISTURB/MAKE MY ROOM (2 Module)				
102560	i-Touch DND / Make My Room / Please Wait (Inside Room)	2100.00	2500.00	5/100
102561	i-Touch DND / Make My Room / Please Wait with Bell Push Switch (Outside Room) Supply voltage 160-240V~ (Inside & outside unit are connected to each other)	2300.00	2700.00	5/100

32A MAIN SWITCH (3 Module)				
103562	32A DP Operated by Key Tag 240V~, LED Supplied with Key Tag For key tag please refer Curve product 102164	571.00	627.00	5/150

32A MAIN SWITCH (2 Module)				
102563	32A DP Operated by Key Tag 240V~, LED Supplied with Key Tag	680.00	748.00	10/300
102564	Only Key Tag with Name Plate	121.00	131.00	N.A.

25A ELECTRONIC BADGE SWITCH (3 Module)				
103565	Electronic Switch with Smart Card 25A, 160-240V~ 50-60Hz with indicator (LED) & Integral relay having exit delay. For smart card please refer Curve product 103166	1737.00	1907.00	5/100

BELL INDICATOR (6 Module) 240~				
106567	Bell Indicator with 6 Display Units with buzzer, reset switches & name plate	1699.00	1899.00	5/100

Code	Item	MRP ₹		Pkg.
		Absolute White	Digital Silver Titanium Grey	
DND/MAKE MY ROOM 240~ (2 Module)				
102568	Do Not Disturb/Make My Room 240V~ 50-60Hz - Inside Room	499.00	544.00	10/300
102569	Do Not Disturb/Make My Room 240V~ 50-60Hz - Outside Room	533.00	578.00	10/300
USB CHARGER / INTERNATIONAL SOCKET				
102570	65W C-Type Fast Charger - Single Port (2M) NEW Supply voltage 160-240V~ 50-60Hz Output - PD USB Charger C type (Max 65W)	-	-	5/100
101571	USB Fast Charger - Single Port (1M) Supply voltage 160-240V~ 50-60Hz Output - 5V = 1.50A / 9V = 1.45A, A type (Max 14W)	998.00	1097.00	10/300
102573	USB Charger - Double Port (2M) Supply voltage 160-240V~ 50-60Hz Output - 5V DC, 2A, A type (Total)	966.00	1063.00	5/100
103574	USB Charger & 10A Int. Socket (3M) Supply voltage 160-240V~ 50-60Hz Output - 5V DC, 2A, A type (Total)	1310.00	1439.00	5/100
101575	18W C-Type Fast Charger - Single Port (1M) Supply voltage 160-240V~ 50-60Hz Output - 5V = 1.50A / 9V = 1.45A USB Charger C type (Max 18W)	1350.00	1410.00	10/300

AUDIO - VIDEO SOCKET (1 Module)				
101577	HDMI Socket	1050.00	1157.00	5/150

ROUTER + EXTENDER (3 Module)				
103580	Wi-Fi Router + Extender 300 MBPS wi-fi wireless router with Ethernet port, In-built USB port for internet connectivity and charging devices. Also support 4G dongle.	4500.00	5000.00	5/100

CAMERA / IP CAMERA				
102598*	Camera (2M) Automatic day/night switching, Camera can be manually swivelled 20° horizontally & vertically Automatic background lighting compensation, Automatic gain control (AGC) Protection type IP 44	-	9449.00	5/100
103599*	IP Camera (3M) Automatic day/night switching, Camera can be manually swivelled 20° horizontally & vertically Automatic background lighting compensation, Automatic gain control (AGC) Supply voltage 160-240V~	-	14400.00	5/100

i-SENSE SENSO SWITCH (2 Module)				
102601	i-Sense Senso Switch Supply voltage 160-240V~ 6A relay output Allows to control lights by simply passing the hand in front of it (Max distance 50mm). 2 units can be combined to control the same light (2 way function).	2999.00	3300.00	5/100

* introducing shortly





Code	Item	MRP ₹		Pkg.
		Absolute White	Digital Silver Titanium Grey	
i-SENSE FM RADIO / BLUETOOTH PLAYER				
102603*	i-Sense FM Radio (2M) Feather touch FM radio with digital display 87-50 MHz, 30 Station Memory with scanner	-	6100.00	5/100
103604	i-Sense FM Radio / Bluetooth (3M) FM & Bluetooth player Mode selection - FM & Bluetooth, Audio output - Stereo Line out - Can be connected to any music system, home audio system, speakers i.e ceiling or inwall through amplifier via Line out, Supply voltage 240V- - Amplifier supplied separately - 101320	2500.00	-	5/108
i-FEEL RF SWITCHES / BELL PUSH SWITCH [2 Module]				
102626	i-Feel 2 Switch Supply voltage 160-240V-, 6A relay output Operating load (CFL & LED): 100W Max (per switch) Radio Frequency : 433.92 Mhz - Can also be operated by RF Remote control-103268 or web/mobile application via Gateway-101646	3500.00	3850.00	5/100
102630	i-Feel Bell Push Switch Supply voltage 160-240V- 2A relay output	2000.00	2200.00	5/100
i-FEEL RF 20A SWITCH [2 Module]				
102632	i-Feel 20A Switch Supply voltage 160-240V-, 20A relay output Operating load (CFL & LED): 200W Max Air Conditioner: 2 ton Radio Frequency : 433.92 Mhz Can also be operated by RF Remote control-103268 or web/mobile application via Gateway-101646	3700.00	4070.00	5/100
i-FEEL RF DIMMER / FAN REGULATOR [2 Module]				
102634*	i-Feel Light Dimmer Supply voltage 160-240V-, Triac Technology with soft end & soft start function Operating load LED: 80W Incandescent Light: 40-450W Not suitable for Fan	3500.00	3850.00	5/100
102636	i-Feel Fan Regulator Supply voltage 160-240V- Variable Capacitance based 4 step regulator Operating load (Fan) : 100W Radio Frequency: 433.92 Mhz Can also be operated by RF Remote control-103268 or web/mobile application via Gateway-101646	3500.00	3850.00	5/100
i-FEEL RF DRAPE CONTROLLER [2 Module]				
102638	i-Feel Drape Controller Supply voltage 160-240V- 2.5A relay output Electronic RF Drape Controller suitable for AC Motor Radio Frequency : 433.92 Mhz Can also be operated by RF Remote control-103268 or web/mobile application via Gateway-101646	3600.00	3960.00	5/100
i-REMOTE CONTROL / ENOCEAN SWITCH				
101926	i-Remote with Micro USB Cable Wifi-IR Remote Control Universal Infrared Remote Control Can operate TV, Set Top Box, AC and other IR Remotes Works with WiFi through iWorld App or Voice Command (Google Home / Amazon Alexa)	-	2999.00	1/1
ENS0001#	Enocean Switch - 2M NEW 4 Button Controller for G-mesh (BLE) #Please refer KNX Catalog *introducing shortly	9000.00	9750.00	1/1

Code	Item	MRP ₹		Pkg.
		Absolute White	Digital Silver Titanium Grey	
i-TOUCH WI-FI 6A & 20A SWITCH [2 Module]				
102901	i-Touch - Wi-Fi 2 Switch Supply voltage 160-240V-, 6A relay output Operating load (CFL & LED): 100W Max (per switch) Radio Frequency : 433.92 Mhz	4900.00	5400.00	5/100
102903	i-Touch - Wi-Fi 20A Switch Supply voltage 160-240V-, 20A relay output Operating load (CFL & LED): 200W Max Air conditioner: 2 ton Radio Frequency : 433.92 Mhz Can also be operated by RF Remote control-103268 or via Wi-Fi Internet (without Gateway)	4900.00	5400.00	5/100
i-TOUCH WI-FI DIMMER/FAN REGULATOR [2 Module]				
102906	i-Touch Wi-Fi Dimmer Supply voltage 160-240V-, Triac Technology with soft end & soft start function Operating load (LED): 80W (Max) Incandescent Light: 40-450W Not suitable for Fan	4900.00	5400.00	5/100
102907	i-Touch Wi-Fi Fan Regulator Supply voltage 160-240V- Variable Capacitance based 4 step regulator Operating load (Fan) : 100W Radio Frequency : 433.92 Mhz Can also be operated by RF Remote control-103268 or via Wi-Fi Internet (without Gateway)	4900.00	5400.00	5/100
i-TOUCH WI-FI DRAPE CONTROLLER [2 Module]				
102909	i-Touch Wi-Fi Drape Controller Supply voltage 160-240V- 2.5A relay output Electronic RF Drape Controller suitable for AC Motor Radio Frequency : 433.92 Mhz Can also be operated by RF Remote control-103268 or via Wi-Fi Internet (without Gateway)	4900.00	5400.00	5/100
i-TOUCH WI-FI SWITCH [3 Module]				
103913	i-Touch - Wi-Fi 4 Switch with Master Supply voltage 160-240V-, 6A relay output Operating load (CFL & LED): 100W Max (per switch) Radio Frequency : 433.92 Mhz	7200.00	7950.00	5/100
103916	i-Touch - Wi-Fi 2 Switch + 1 Fan Regulator with Master Supply voltage 160-240V-, 6A relay output Operating load (CFL & LED): 100W Max (per switch) Radio Frequency : 433.92 Mhz Can also be operated by RF Remote control-103268 or via Wi-Fi Internet (without Gateway)	8300.00	9150.00	5/100
i-TOUCH WI-FI PANEL 240V- [2 & 4 Module] NEW				
102920	i-Touch - Wi-Fi 4 Switch (With Glass Plate) Supply voltage 160-240V-, 6A relay output Operating load (CFL & LED): 100W Max (per switch) Radio Frequency : 433.92 Mhz	-	7600.00	5/-
104924	i-Touch - WiFi 4 Switch + Fan Reg. + 2 USB Port (With Glass Plate) Supply voltage 160-240V-, 6A relay output Operating load (CFL & LED): 100W Max (per switch) Radio Frequency : 433.92 Mhz Variable Capacitance based 5 Step Fan Regulator USB Output: 5V 2A DC (Max) Can also be operated by RF Remote control-103268 or via Wi-Fi Internet (without Gateway)	-	11500.00	5/-
i-TOUCH WI-FI PANEL 240V- [6 Module]				
106925	i-Touch - WiFi 6 Switch + Fan Reg. + 2 USB Port + Int. Socket (With Glass Plate) Supply voltage 160-240V-, 6A relay output Operating load (CFL & LED): 100W Max (per switch) Radio Frequency : 433.92 Mhz Variable Capacitance based 5 Step Fan Regulator USB Output: 5V 2A DC (Max) Socket: 10A International Socket Can also be operated by RF Remote control-103268 or via Wi-Fi Internet (without Gateway)	-	13500.00	5/-

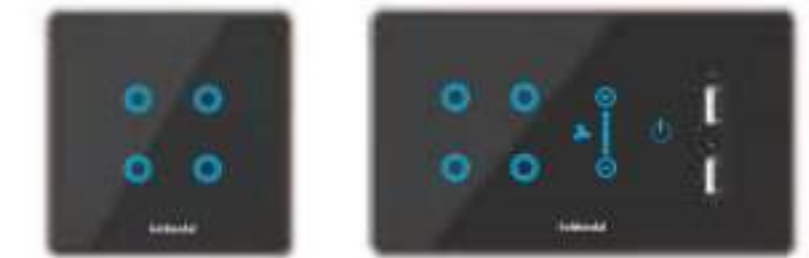



Code	Item	MRP ₹		Pkg.
		Absolute White	Digital Silver Titanium Grey	
I-HOME AUTOMATION				
101646	i-Home Gateway - Compatible with RF Touch, i-Touch & i-Feel products. - Connects electrical functions through a router. - Control from anywhere using your smartphone / tablet / laptop / desktop. - Individual device control as well as scene settings. - Schedule individual devices as well as scenes.	9999.00	-	1/1

STEP MARKER 240V- 50-60Hz - [3 Module]				
103648	Step Marker (LED) Supply voltage 240V- 50-60Hz	563.00	631.00	5/100



i-WORLDAutomation

Goldmedal presents the i-World app. The easiest, most convenient way to monitor, control, and customize all your electrical devices that are part of the i-Touch/i-Smart Wi-Fi ecosystem.

You can not only control devices, but also share this control with others by creating multiple users and setting up different usage rights. So, share control with your family, or restrict usage of certain rooms or devices with other users, or categorize devices by room, or assign administrator rights to someone – the possibilities are simply immense.

The i-World app can also be integrated with Amazon Alexa and Google Home Assistant. Just speak out your wish and the i-World app will do as you command!

Switch to a smarter lifestyle with smart switches from Goldmedal.



Goldmedal i-World
 Download the Goldmedal i-World App on your smart device to control your i-Touch & i-Smart WiFi Switches from anywhere in the world. Download now!

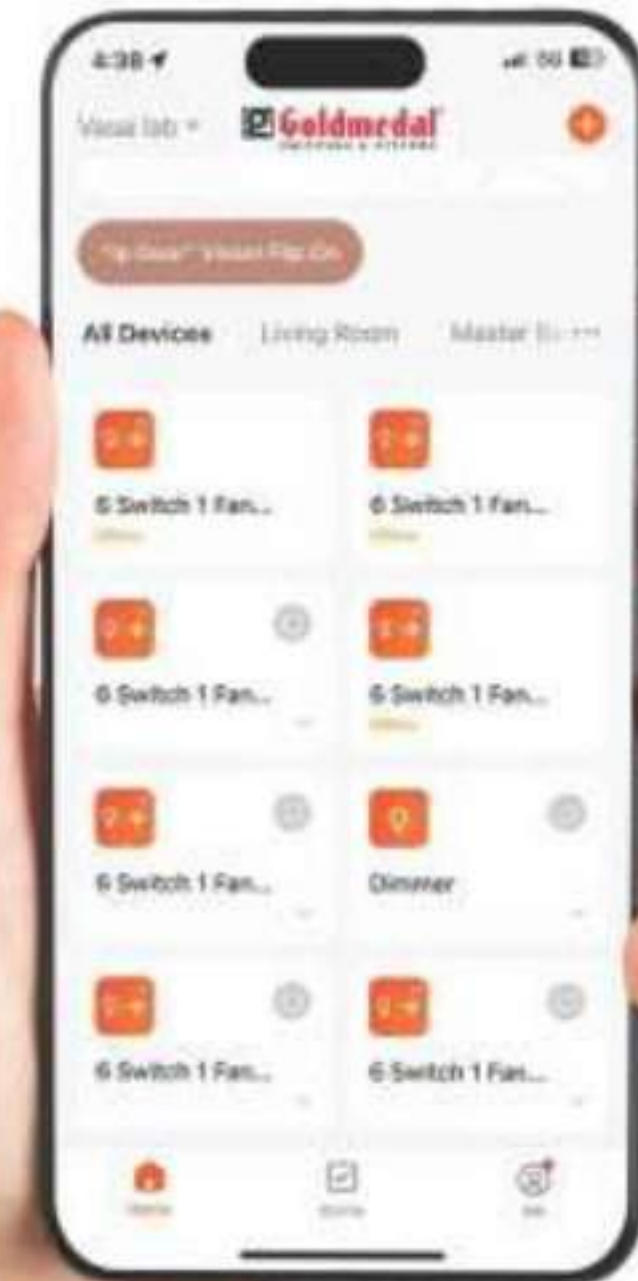

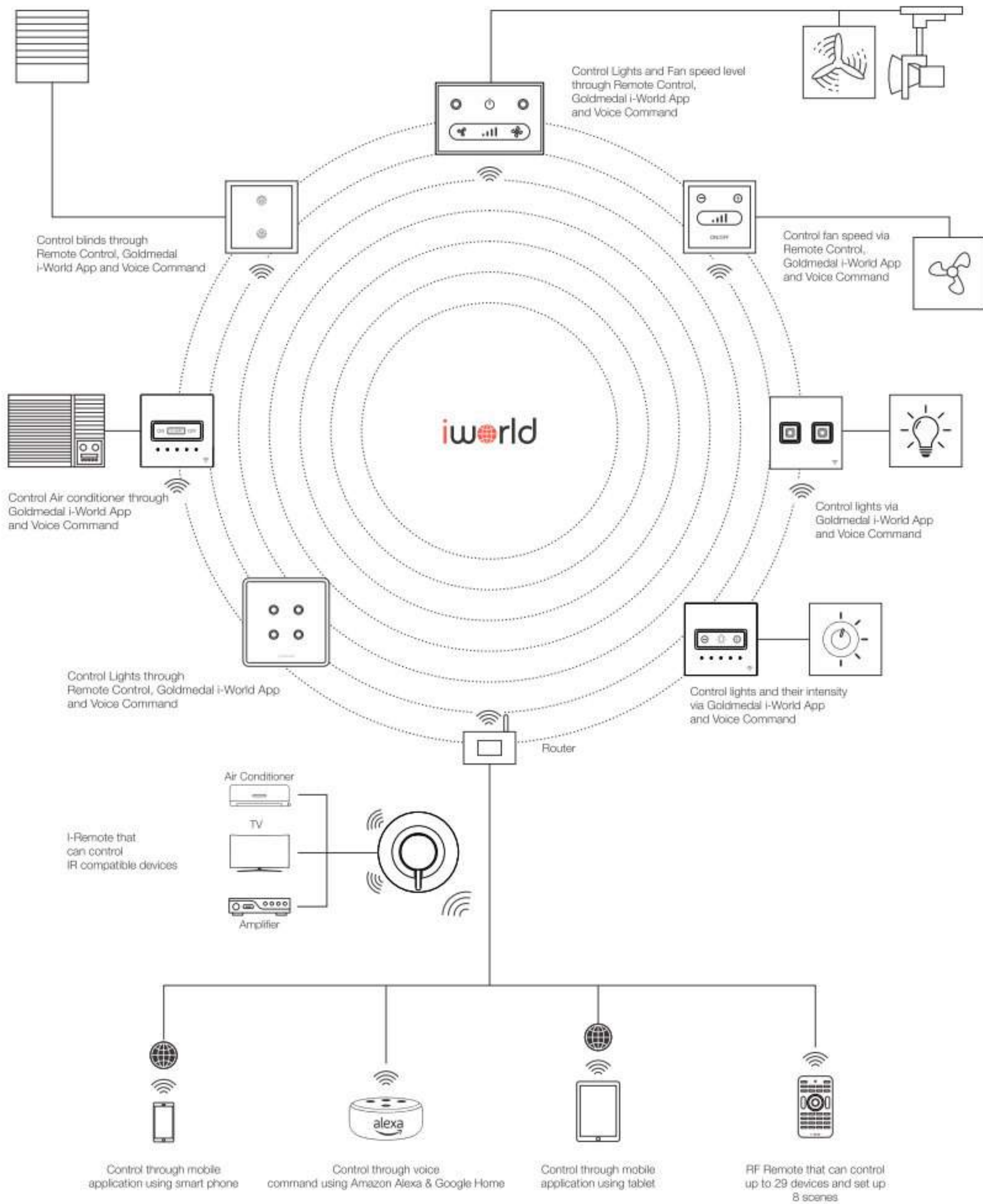

i-TOUCH WI-FI / i-SMART WI-FI / i-TOUCH WI-FI PANEL

Installing i-Touch Wi-Fi/i-Smart Wi-Fi/i-Touch Wi-Fi panel does not require any drilling or additional wiring. Simply plug them into your existing wiring and it's done. These switches and panels are designed with Switched Mode Power Supply (SMPS) for improved reliability, over-current, and over-voltage protection. (For specific installation and technical details, please refer to the technical sheet provided within the product packaging).

i-Touch Wi-Fi 4 Switch with Master (Wiring Diagram)

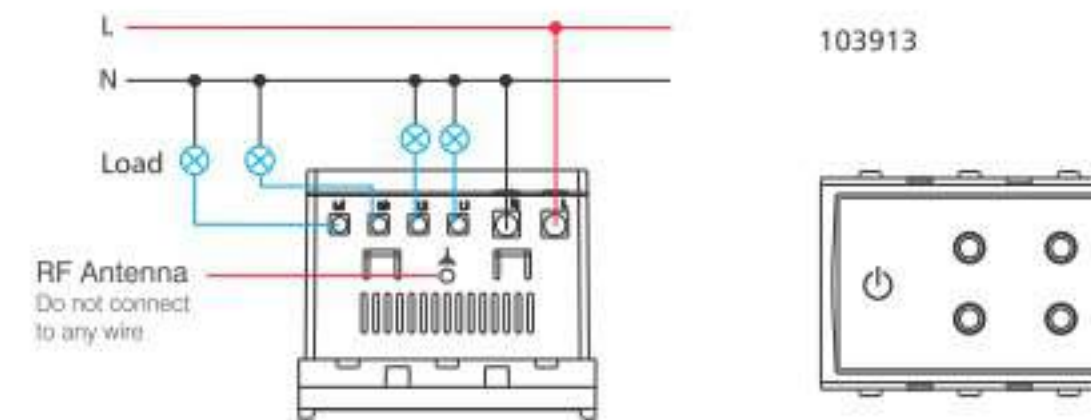

Technical Specifications

- Rated Voltage: 160-240V~ 50-60Hz
- Rated Load per Switch :
- a) Capacitive Load - CFL & LED (PF>0.8) : 100W
- b) Resistive Load - Incandescent & Halogen Lights: 1000 W
- c) Inductive Load - Fan and Motor : 800W
- Service Life: 50,000 Operations

i-Touch Wi-Fi 2 Switch + 1 Fan Regulator with Master (Wiring Diagram)

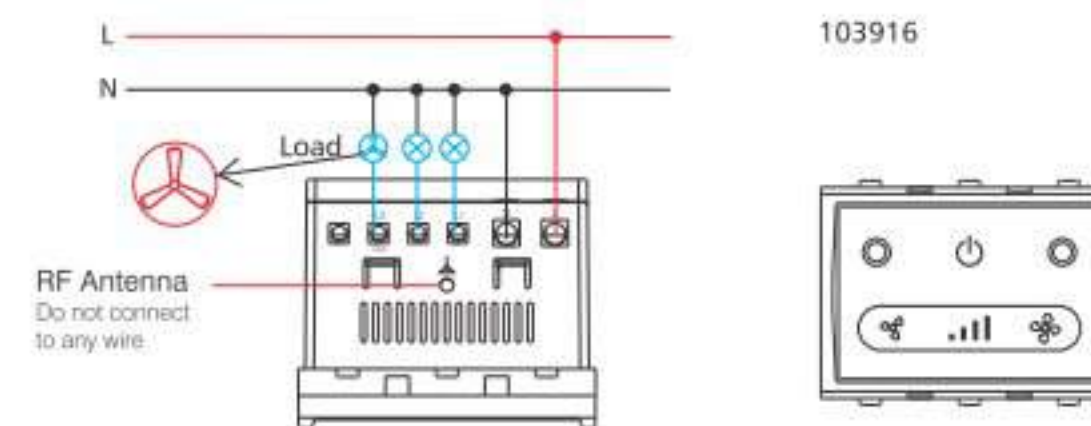

Technical Specifications

- Rated Voltage: 160-240V~ 50Hz
- Rated Load per switch:
- a) Capacitive Load - CFL & LED (PF>0.8) : 100W
- b) Resistive Load - Incandescent & Halogen Lights: 1000 W
- c) Inductive Load - Fan and Motor - 800 W
- Rated Load: Fan Regulator - Max 100 W
- 4-Level Speed Selection with Indicator
- Service Life: 50,000 Operations

i-Smart Fan Regulator (Wiring Diagram)

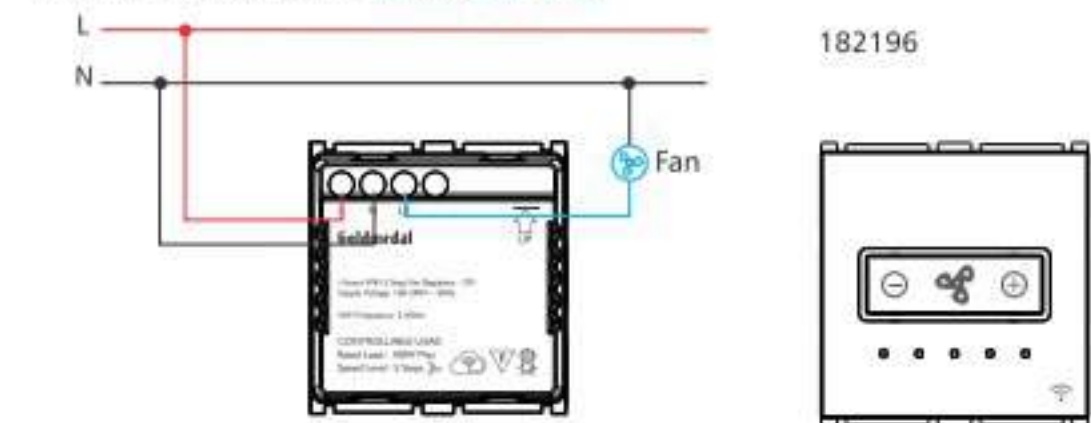

Controllable Load:

- Rated Voltage : 160-240V~ 50Hz
- Rated load : 100W Max
- Speed Level - 5 Steps

i-Touch Wi-Fi 4 Switch + Fan Regulator + 2 USB Port (With Glass Plate) (Wiring Diagram)

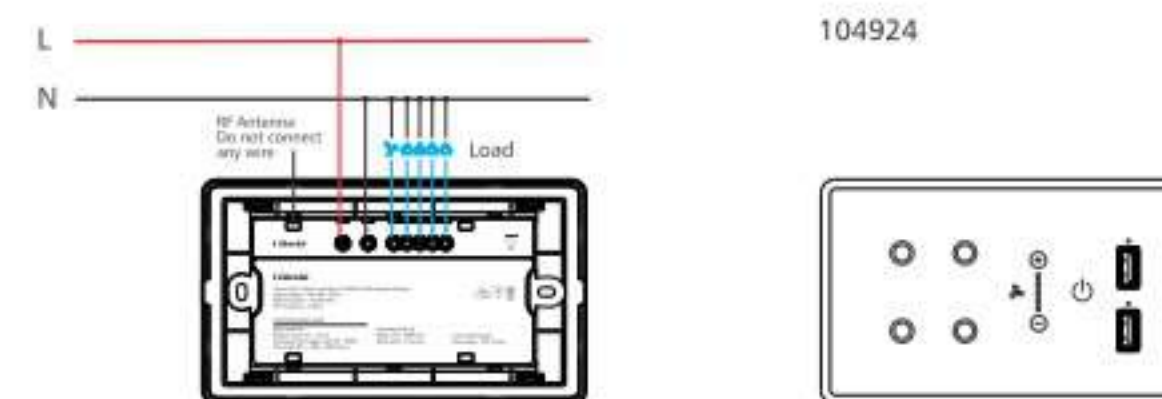

Technical Specifications

- Rated Voltage: 160-240V~ 50Hz
- Rated output (USB): 5.0V DC, 2000mA (max)
- Rated Load per switch:
- a) Capacitive Load - CFL & LED (PF>0.8) : 100W
- b) Resistive Load - Incandescent & Halogen Lights: 1000 W
- c) Inductive Load - Fan and Motor - 800 W
- Rated Load: Fan Regulator - Max 100 W
- 5-Level Speed Selection with Indicator
- Service Life: 50,000 Operations

Wire colour codes: ■ Red (live),
■ Black (neutral),
■ Blue (load).



The circle of power and style.



Boomeroo
Pop-Up Multi Socket Cabinet
(Concealed - Table Mounted)

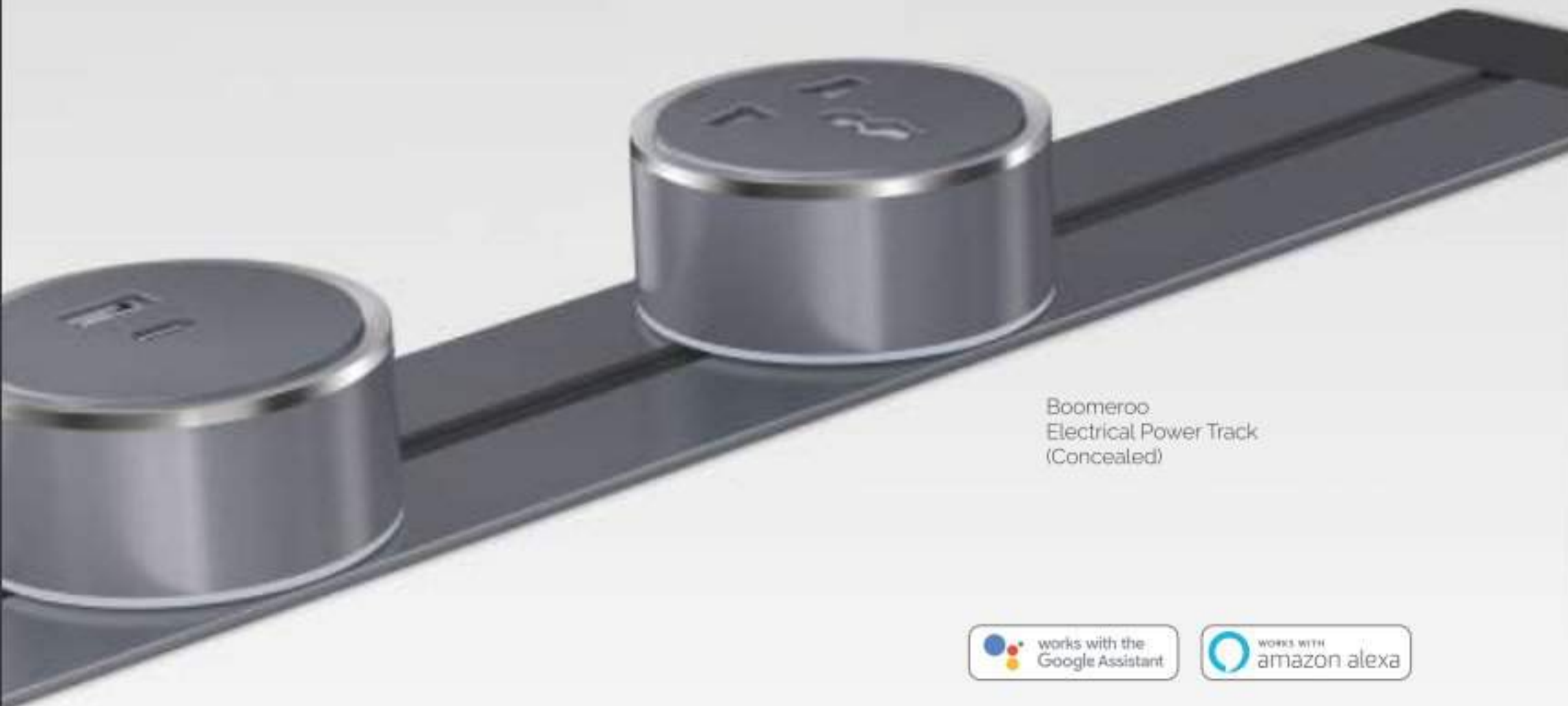

Boomeroo
Electrical Power Track
(Concealed)



The Boomeroo multiplug, smart pop-up socket revolutionizes workspace connectivity by integrating features such as a wireless charger, Bluetooth speaker, USB socket, and inductive touch switch. Meanwhile, the Boomeroo power track and movable sockets offer unparalleled flexibility that allows you to power or charge your devices conveniently. Both devices are perfect for enhancing functionality and convenience across various settings such as office tables, meeting tables, insular shelves, bar counters, kitchen worktops, desks, and exhibition rooms. They offer a seamless blend of technology and design, catering to the modern, dynamic workspace.

Code	Item	MRP ₹		Pkg. Outer/ Master
		Grey		

BOOMEROO ELECTRICAL POWER TRACK CONCEALED NEW

105001	Boomeroo Power Track 60cm Size: 8x1.9x60 (WxHxL)	-	7000.00	1/20
105002	Boomeroo Power Track 100cm Size: 8x1.9x100 (WxHxL)	-	9000.00	1/15
105003	Boomeroo Power Track 150cm Size: 8x1.9x150 (WxHxL)	-	13500.00	1/08

Supply Voltage : 110 -250V- 50Hz
Rated Current: 32A Rated Power:8000W (Max)
-IP 20, Aluminum alloy, Integrated copper bar
with safety shutter

(Above size mentioned is in CM)

BOOMEROO ELECTRICAL POWER TRACK SURFACE WITH LED NEW

105006	Boomeroo Power Track 50cm Size: 8.6x1.9x50 (WxHxL)	-	12000.00	1/20
105007	Boomeroo Power Track 80cm Size: 8.6x1.9x80 (WxHxL)	-	14000.00	1/15

Supply Voltage : 110 -250V AC 50Hz
Rated Current: 32A
Rated Power: 8000W (Max)
Light Output: 8W (6500K)
-IP 20, Aluminum alloy, Integrated copper bar
with safety shutter

(Above size mentioned is in CM)

BOOMEROO TABLE MOUNTED TRACK SOCKET NEW

105011	Boomeroo Universal Socket Socket: 10A Universal Socket	-	1000.00	1/120
105012	Boomeroo USB Charger A & C Type USB Output: 5V=2.4A	-	2400.00	1/120

BOOMEROO POP-UP MULTI SOCKET CABINET NEW

105021	Boomeroo Pop-Up Multi Socket Cabinet (Concealed-Table Mounted) Supply Voltage : 220-240V - 50Hz USB Type-A Output: 5V=2.1A USB Type-C Output : 5V=2.1A/9V=2.25A/12V=1.66A Wireless Charging: 15W(Max) Socket : 13A Universal Socket Soft Touch based lifting function FM, Bluetooth Player, USB & Recording Mode Audio Output: Stereophonic Speaker 3W Opening Size: 95mm (Circle hole of table) Can also be operated by Goldmedal i-World app and supports voice assistants Google and Alexa.	-	-	1/20
--------	---	---	---	------





Bella White Jazz Plate with Curve White Jazz Switches

bella

You are mesmerized by the smile of a newborn; you wonder at the precision of a perfectly drawn line. Part dreamer, part realist, you synchronize your lifestyle with the demands of your heart and mind. You'll find an expression of this rare combination in the bella range of cover panels. Choose from the natural opulence of Bellewood panels, the elegant simplicity of White Jazz, the passion and energy of Metalik, the exuberance of Antik, or the soft-to-touch feel of Bellesoft. The options on offer are simply a myriad.

Bella Spirit Gold Plate with Nixon Titanium Grey Switches



BELLA COVER PLATES WITH MOUNTING FRAMES

PLATES →	1M	2M	3M	3M*	4M	6M	7M*	8M(H)	8M*	8M (V)	8M(V)**	12M	16M	18M
COLOURS ↓	MRP ₹	MRP ₹	MRP ₹	MRP ₹	MRP ₹	MRP ₹	MRP ₹	MRP ₹	MRP ₹	MRP ₹	MRP ₹	MRP ₹	MRP ₹	MRP ₹
White Jazz	96.00	96.00	119.00	119.00	138.00	186.00	227.00	235.00	273.00	235.00	235.00	293.00	322.00	381.00
Metalik	123.00	123.00	159.00	159.00	179.00	235.00	301.00	307.00	342.00	307.00	307.00	386.00	390.00	425.00
Belle Soft	133.00	133.00	174.00	174.00	204.00	263.00	332.00	336.00	373.00	336.00	336.00	425.00	435.00	466.00
Antik	161.00	161.00	201.00	201.00	234.00	311.00	412.00	419.00	457.00	419.00	419.00	469.00	538.00	594.00
Belle Wood	161.00	161.00	201.00	201.00	234.00	311.00	412.00	419.00	457.00	419.00	419.00	469.00	538.00	594.00
CODE →	30101	30201	30301	33301	30401	30601	30701	30801	32801	38801	39801	31201	31601	31801
Outer/Master →	10/400	10/400	10/300	10/300	10/300	5/150	5/150	5/150	5/150	5/150	5/150	5/120	5/90	5/80
SIZE(mm) →	93x86	93x86	119x86	125x86	151x86	219x86	219x86	268x86	246x86	154x155	152x168	220x155	268x155	225x224

COVER PLATES

* Without Partition **8 Module Vertical Big Size

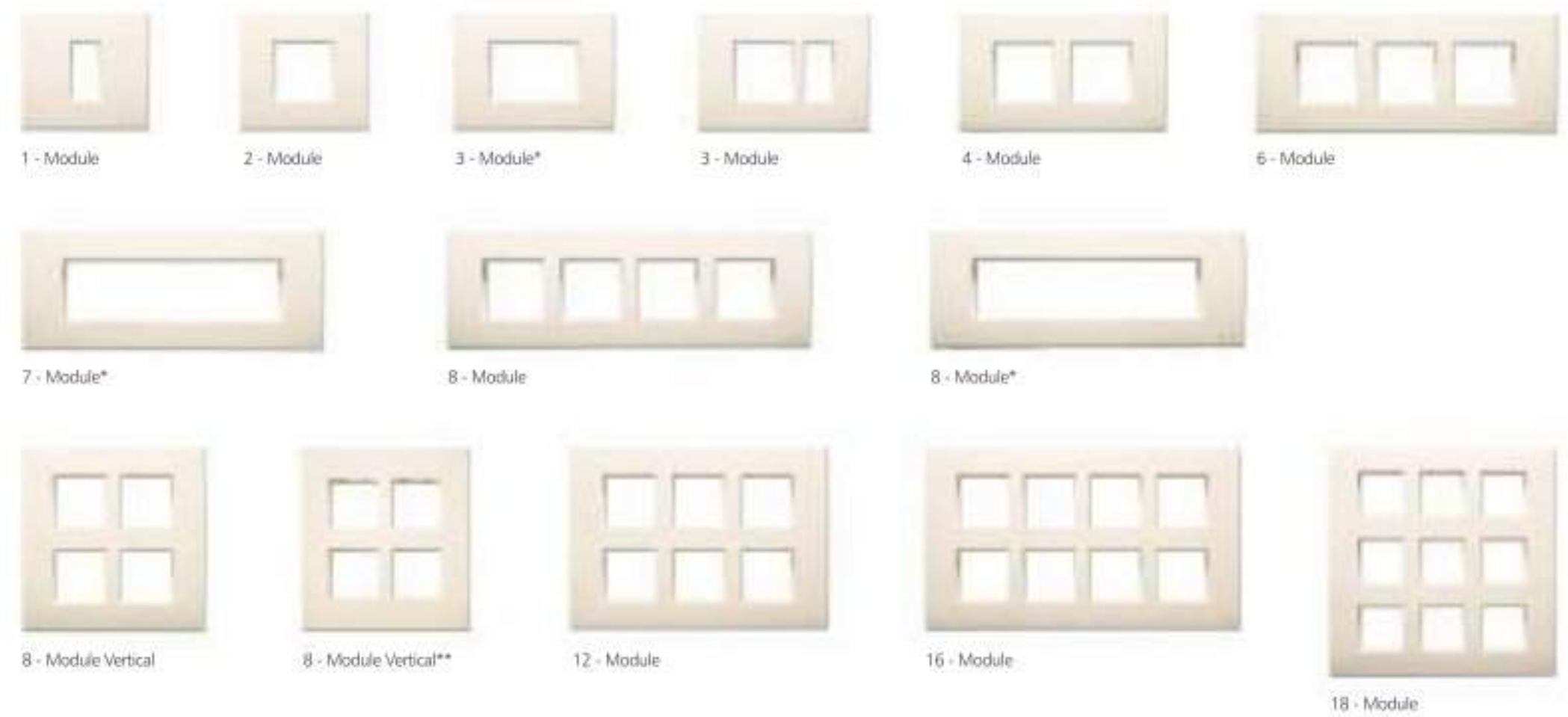

MOUNTING FRAMES - Horizontal & Vertical Distance for Screwing [Dimensions in mm]

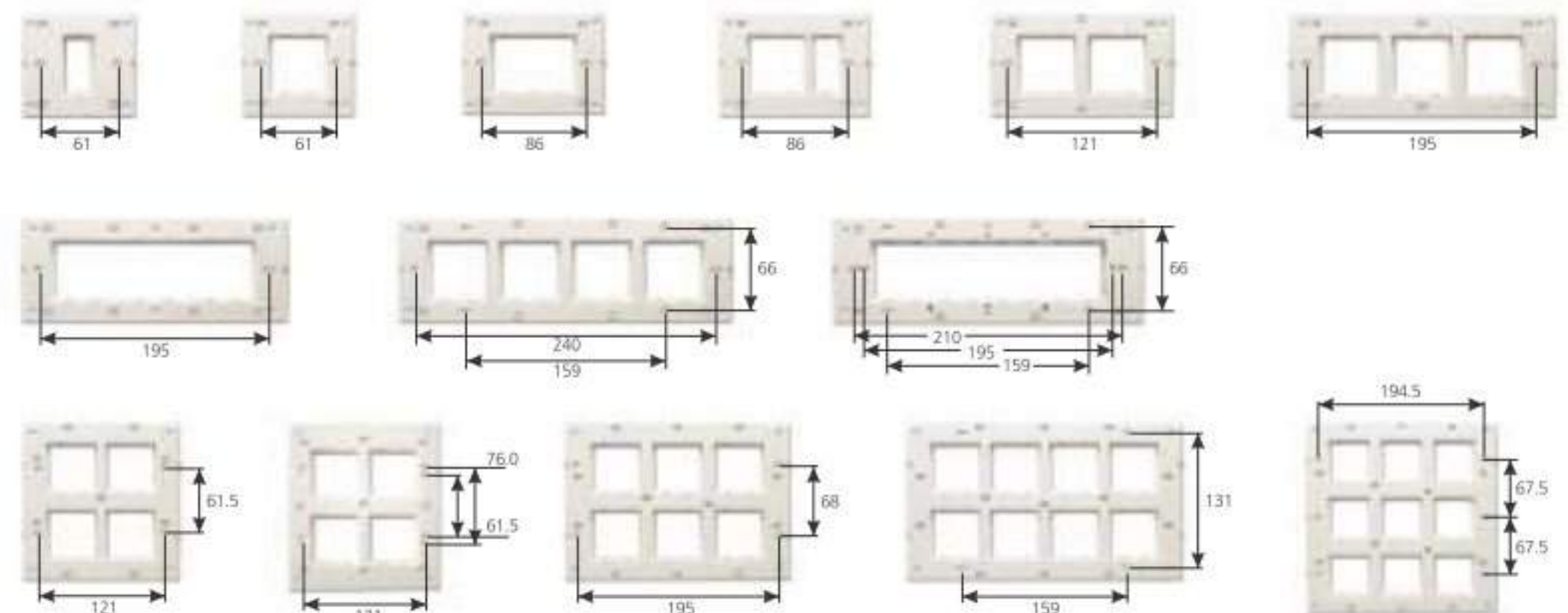

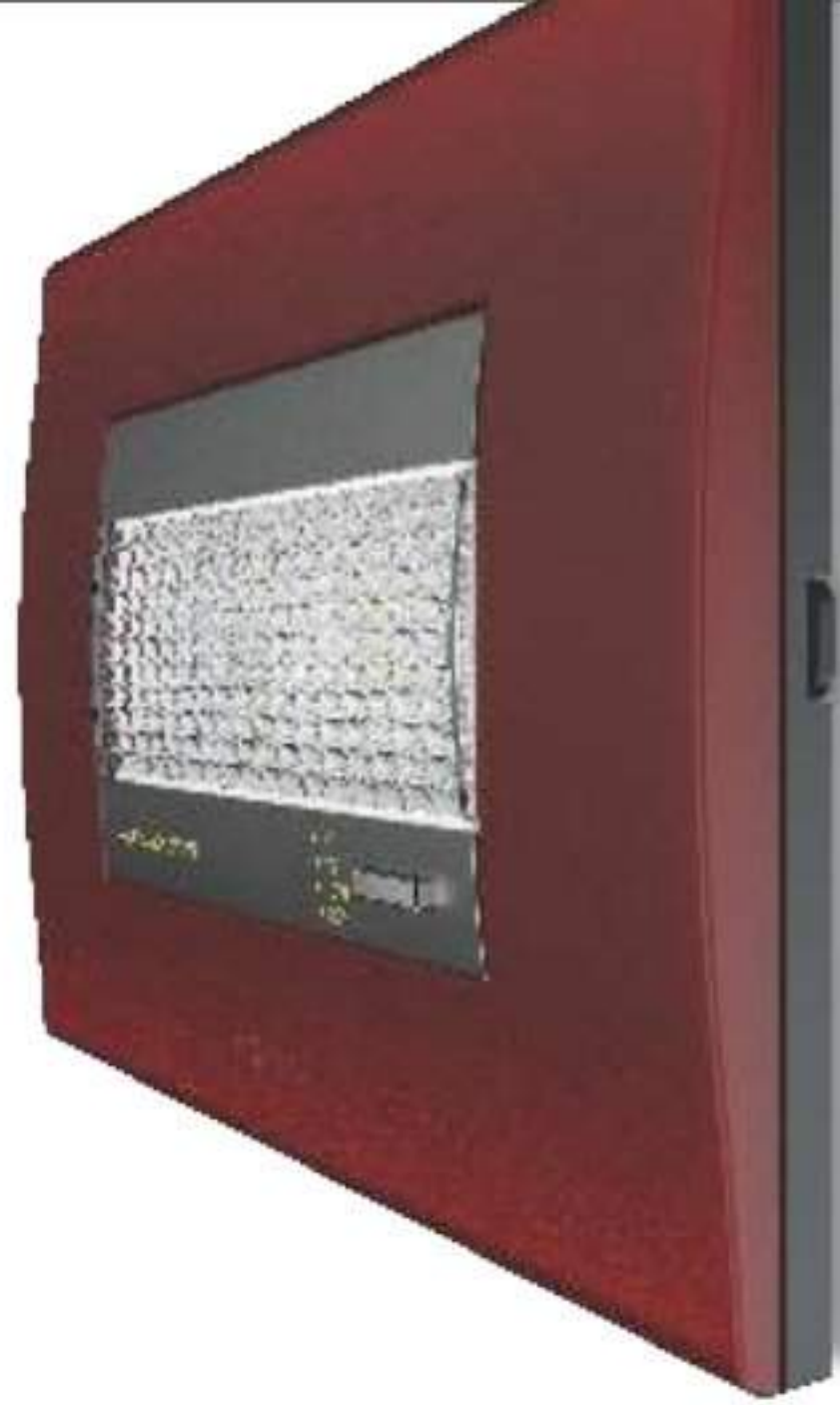

Cristallo Valentine Wine Plate with Curve Digital Chrome Emergency Light

Cristallo

With Curve Cristallo, you can create style statements that echo your true self. Choose the clear, transparent Memorio panels to showcase your memories from the past. Select the specially crafted Twixos panels with two-tone colours to lend a distinct verve to your interiors. Or opt for the Illumino panels that emit a soft, gentle glow that inspires as well as guides you in total darkness... Whichever your choice, the Cristallo range doesn't just allow you to express yourself more clearly, it sets trends for the rest to follow.

Cristallo Herbat Spa Plate with Curve Digital Chrome Switches



CRISTALLO COVER PLATES WITH MOUNTING FRAMES

PLATES →	1M	2M	3M	3M*	4M	6M	8M (H)	8M*	8M (V)	12M	16M	18M
COLOURS ↓	MRP ₹	MRP ₹	MRP ₹	MRP ₹	MRP ₹	MRP ₹	MRP ₹	MRP ₹	MRP ₹	MRP ₹	MRP ₹	MRP ₹
White Jazz	86.00	86.00	108.00	108.00	122.00	165.00	211.00	240.00	211.00	267.00	295.00	339.00
Memorio	198.00	198.00	239.00	239.00	288.00	368.00	501.00	501.00	501.00	551.00	662.00	755.00
Twixos/Metalik	179.00	179.00	231.00	231.00	266.00	327.00	395.00	395.00	395.00	482.00	538.00	616.00
Wood	200.00	200.00	260.00	260.00	304.00	357.00	441.00	441.00	441.00	538.00	597.00	669.00
CODE →	40101	40201	40301	43301	40401	40601	40801	42801	48801	41201	41601	41801
Outer/Master →	10/300	10/300	10/200	10/200	10/200	5/120	5/120	5/120	5/100	5/80	5/40	5/40
SIZE(mm) →	92x86	92x86	115x86	122x86	150x86	222x86	264x86	248x86	150x151	222x151	264x151	223x217

COVER PLATES

* Without Partition

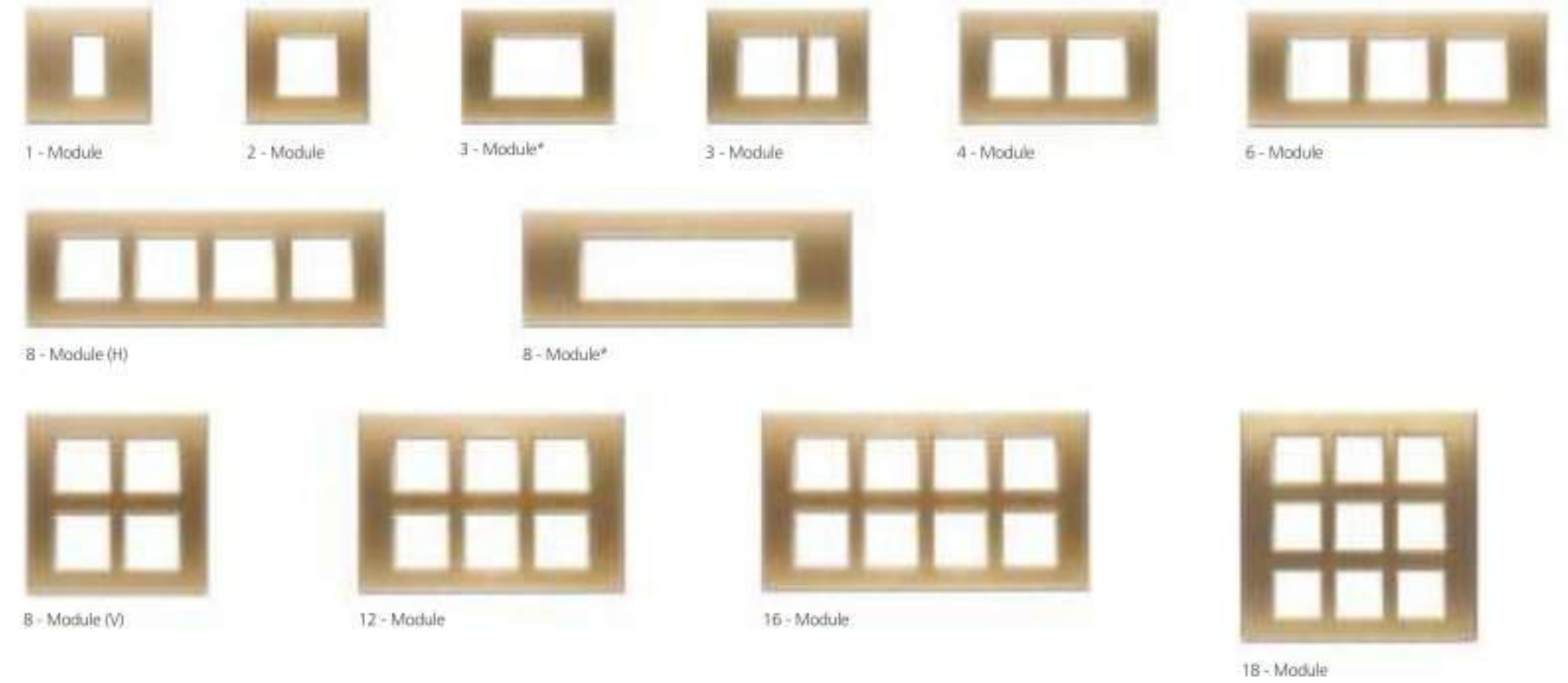

CRISTALLO MOUNTING FRAMES - Horizontal & Vertical Distance for Screwing [Dimensions in mm]

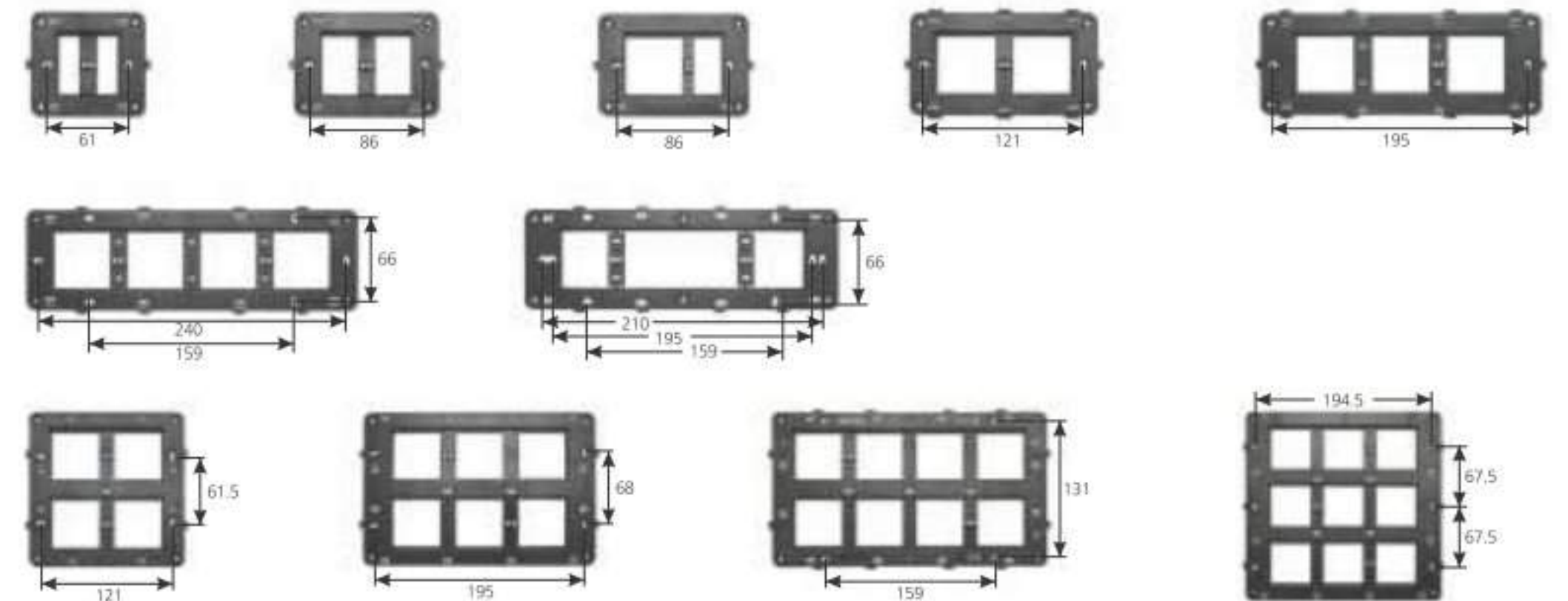



Crystallight Honey Mint Plate with Nixon Titanium Grey Gas Detector

QUORRA

The Crystallight cover frames are precisely crafted for that perfect finish – right from their delicately frosted facade to the exquisite chamfer around the edges. Like naturally occurring crystals, the Crystallight cover plate exhibits a rare brilliance that creates an aura of sophisticated elegance around it. Unmatched in their beauty and finish, these cover plates are without doubt, the definitive symbol of luxury on your walls.

Crystallight Grey Ghost Plate with Nixon Titanium Grey Switches



Crystallight

QUORRA BASIC COVER PLATES

PLATES	1M	2M	3M	4M	4M*	6M	6M*	8M (H)*	8M	8M*	8M (V)	12M	18M
					(H&V)**		(H&V)**			(H&V)**			
COLOURS	MRP ₹	MRP ₹	MRP ₹	MRP ₹	MRP ₹	MRP ₹	MRP ₹	MRP ₹	MRP ₹	MRP ₹	MRP ₹	MRP ₹	MRP ₹
Satin White	-	124.00	157.00	194.00	-	251.00	-	301.00	301.00	-	301.00	381.00	532.00
Metallic	-	205.00	227.00	266.00	-	320.00	-	387.00	387.00	-	387.00	534.00	654.00
Wood	-	240.00	266.00	333.00	-	387.00	-	480.00	480.00	-	480.00	654.00	867.00
Outer/Master	-	10/400	10/300	10/300	-	5/150	-	5/150	5/150	-	5/150	5/120	5/80

QUORRA PREMIUM COVER PLATES

Glass	581.00	581.00	784.00	1034.00	1136.00	1405.00	1532.00	-	1584.00	1724.00	1584.00	1874.00	2274.00
CODE	50101	50201	53301	50401	50403	50601	50603	50801	52801	50803	58801	51201	51801
Outer/Master	10/200	10/200	10/200	10/150	10/150	5/100	5/100		5/100	5/100	5/100	5/75	5/40
SIZE(mm)	106x91	106x91	128x91	152x91	152x91	226x91	226x91	-	251x91	269x91	152x157	226x157	226x224

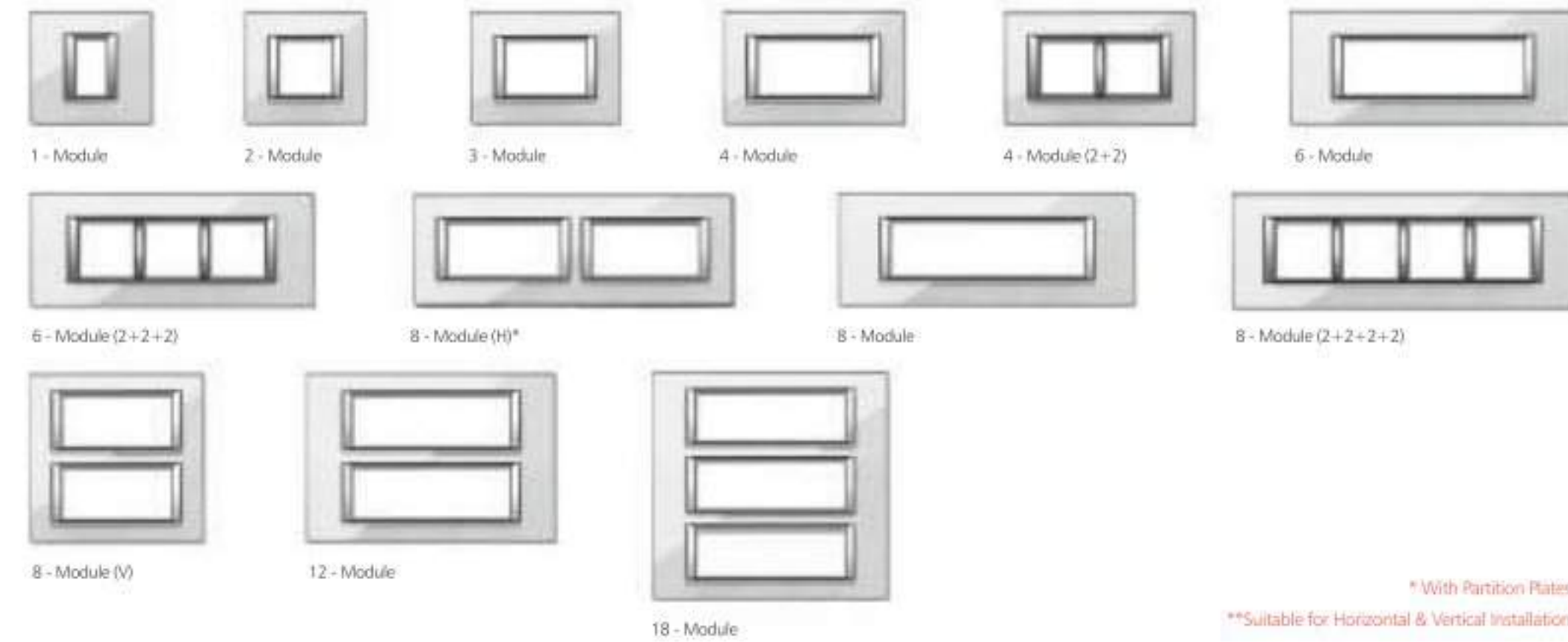

* With Partition Plates

** Suitable for Horizontal & Vertical Installation

QUORRA MOUNTING FRAME - Horizontal & Vertical Distance for Screwing (Dimensions in mm)

Quorra Frame	2M	3M	4M	4M	6M	6M	8M (H)*	8M	8M	8M (V)	12M	18M
					(H&V)**	(H&V)**			(H&V)**			
MRP ₹	64.00	78.00	90.00	96.00	131.00	143.00	164.00	164.00	179.00	164.00	210.00	285.00
CODE	50202	53302	50402	50404	50602	50604	50802	52802	50804	58802	51202	51802
Outer/Master	25/750	25/750	25/500	25/500	20/240	20/240	20/240	20/240	20/240	20/240	20/160	10/80

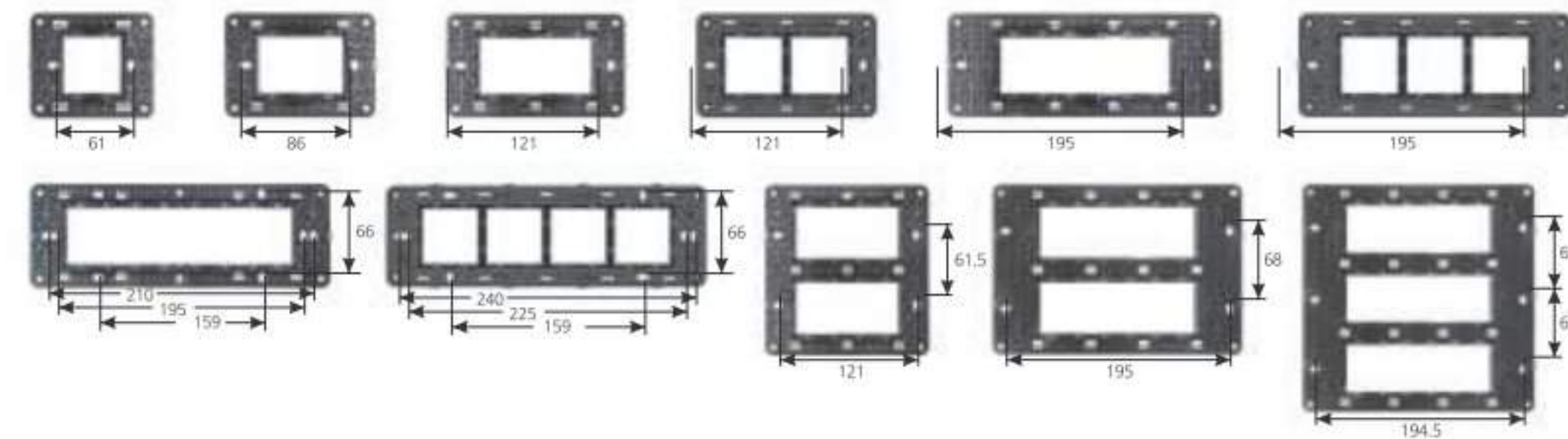



Xtreme Brushed Silver Plate with Nixon Titanium Grey Step Marker

QUORRA

Fashioned from wood, glass, metal, chrome, stone and wool, the Quorra Xtreme cover frames are distinguished by their sleek chrome encasing. Visible from the sides as well as the front, the chrome border creates an aura of luxury and sophistication around the frames. While the Quorra Xtreme is superlative in every respect, the Quorra Xtreme is the epitome of flawless grandeur; diamond cut and polished to perfection. Painstakingly crafted, Quorra cover frames symbolizes the absolute pinnacle of luxurious living.

XTREME

Xtreme Brushed Silver Plate with 3M Bluetooth FM Player



QUORRA CRYSTALLIGHT / DIAMOND COVER PLATES

PLATES	➔	1M	2M	3M	4M	4M*	6M	6M*	8M	8M*	8M (V)	12M	18M
						(H&V)**		(H&V)**		(H&V)**			
COLOURS	↓	MRP ₹	MRP ₹	MRP ₹	MRP ₹	MRP ₹	MRP ₹	MRP ₹	MRP ₹	MRP ₹	MRP ₹	MRP ₹	MRP ₹
Glass (diamond cut)		656.00	656.00	882.00	1161.00	1277.00	1674.00	1761.00	1881.00	1940.00	1881.00	2112.00	2588.00
Diamond (studded)		-	-	4896.00	-	-	-	-	-	-	-	-	-

QUORRA XTREME COVER PLATES

Aluminum		600.00	600.00	855.00	1136.00	1250.00	1608.00	1742.00	1854.00	1922.00	1854.00	2105.00	2591.00
CODE	➔	50101	50201	53301	50401	50403	50601	50603	52801	50803	58801	51201	51801
Outer/Master	➔	10/200	10/200	10/200	10/150	10/150	5/100	5/100	5/100	5/100	5/100	5/75	5/40
SIZE(mm)	➔	106x91	106x91	128x91	152x91	152x91	226x91	226x91	251x91	269x91	152x157	226x157	226x224

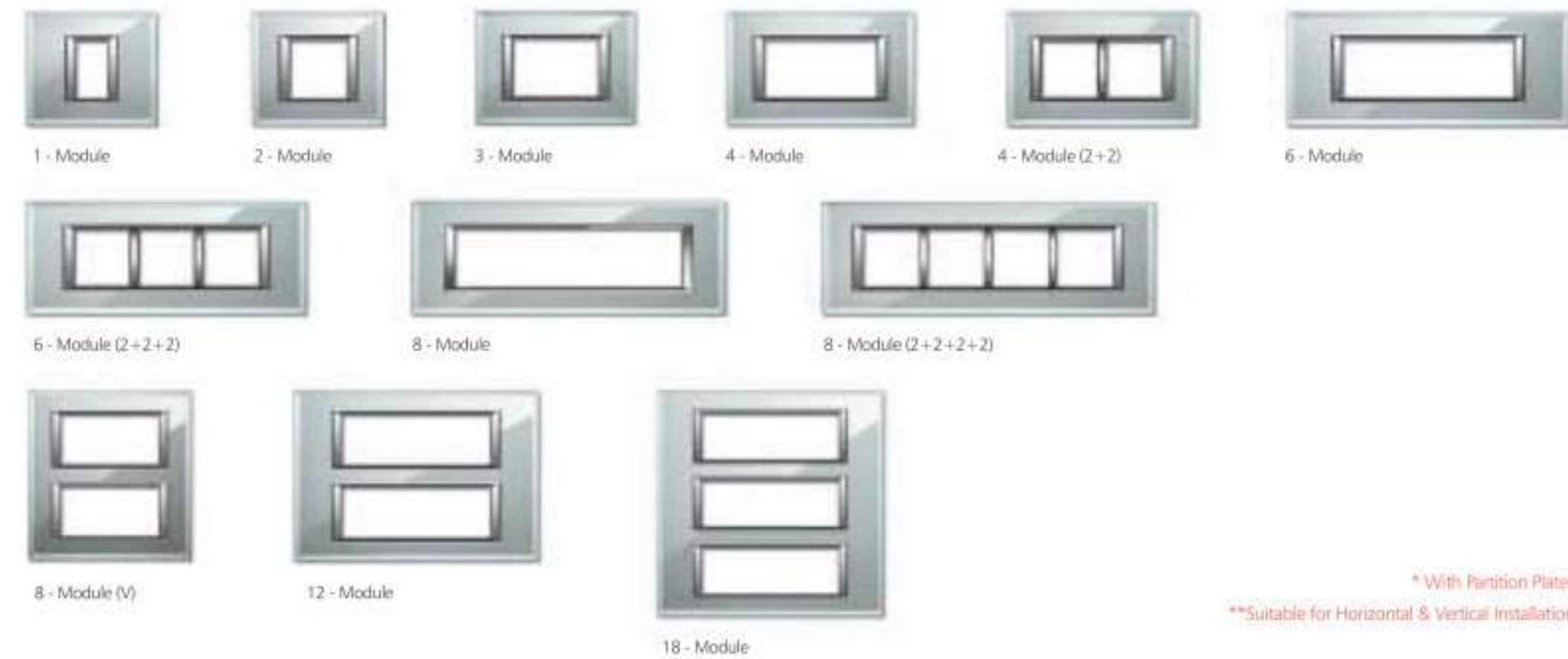

* With Partition Plates
** Suitable for Horizontal & Vertical Installation

QUORRA XTREME COVER PLATES

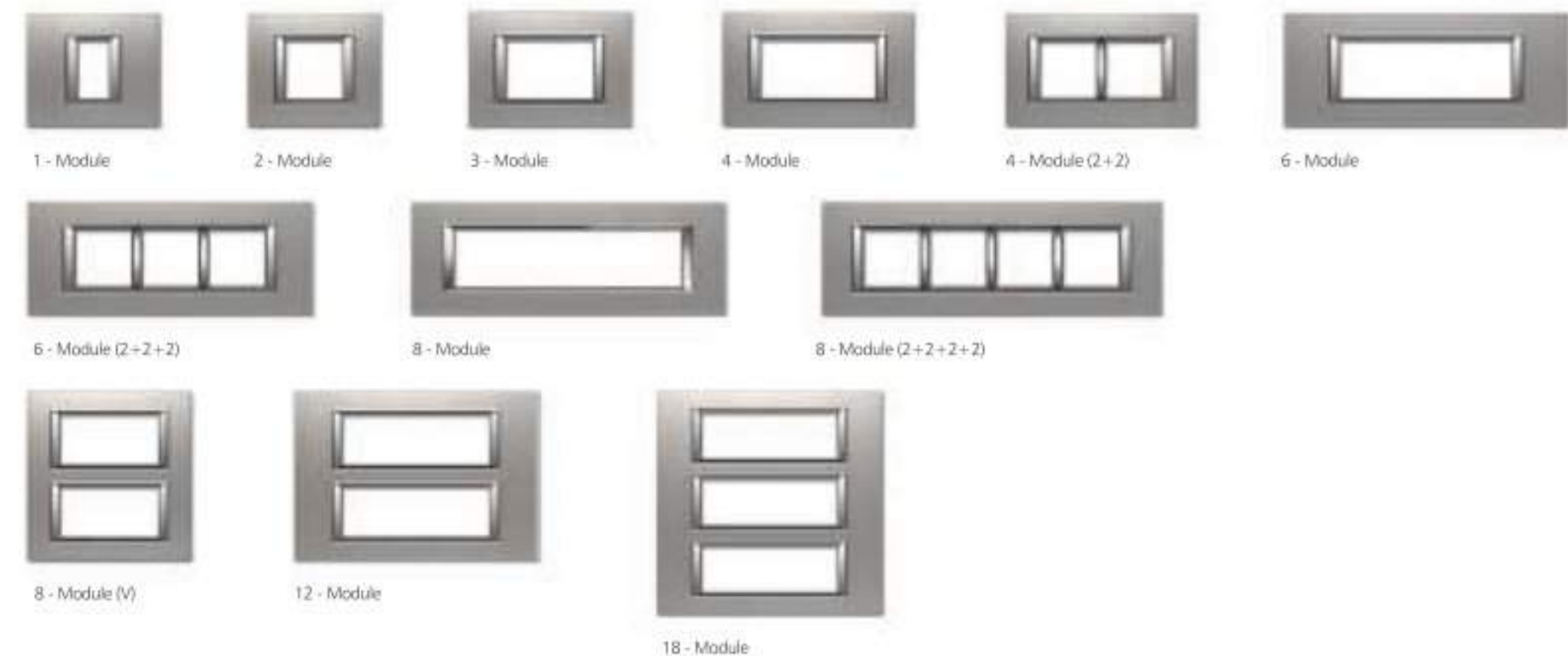



Grazia Basic Moughal Teak Plate with Nixon Digital Silver Switches

grazia

Grazia, the thinnest, most stylish cover frames you can imagine, are available in Basic and Premium options. Both Basic and Premium cover frames accentuate the style quotient of your rooms with their distinctively slender appearance. The Grazia Premium has an additional chrome side casing which highlights the delightful slimness of these cover frames. Choose from either of these options to make a style statement that will always be in.

Grazia Premium Italian Espresso Plate with Digital Silver Key Tag



GRAZIA BASIC COVER PLATES WITH MOUNTING FRAMES

PLATES →	1M	2M	3M	3M*	4M	4M*	6M	6M*	8M	8M*	8M	9M*	12M	12M*	12M*	16M	18M
						(H&V)**		(H&V)**		(H&V)**	(V)				(H&V)**		
COLOURS ↓	MRP ₹	MRP ₹	MRP ₹	MRP ₹	MRP ₹	MRP ₹	MRP ₹	MRP ₹	MRP ₹	MRP ₹	MRP ₹	MRP ₹	MRP ₹	MRP ₹	MRP ₹	MRP ₹	MRP ₹
Pure Glossy	103.00	103.00	127.00	127.00	158.00	158.00	224.00	224.00	281.00	281.00	281.00	301.00	322.00	322.00	322.00	356.00	407.00
Metallic	149.00	149.00	193.00	193.00	235.00	235.00	323.00	323.00	404.00	404.00	404.00	433.00	473.00	473.00	473.00	518.00	523.00
Wood	199.00	199.00	270.00	270.00	330.00	330.00	450.00	450.00	615.00	615.00	615.00	619.00	631.00	631.00	631.00	692.00	735.00

GRAZIA PREMIUM COVER PLATES WITH MOUNTING FRAMES

Pure Glossy	121.00	121.00	149.00	149.00	181.00	181.00	260.00	260.00	330.00	330.00	330.00	353.00	377.00	377.00	377.00	424.00	481.00
CODE →	60101	60201	60301	60303	60401	60404	60601	60604	60801	60804	68801	60901	61201	61204	61207	61601	61801
Outer/Master	10/400	10/400	10/300	10/300	10/300	10/300	5/150	5/150	5/150	5/150	5/150	5/150	5/120	5/120	5/120	5/90	5/80
SIZE(mm) →	101x93	101x93	124x93	124x93	148x93	154x93	221x93	226x93	247x93	280x93	148x159	280x93	222x160	226x160	226x160	246x159	222x226

* With Partition Plates

**Suitable for Horizontal & Vertical Installation

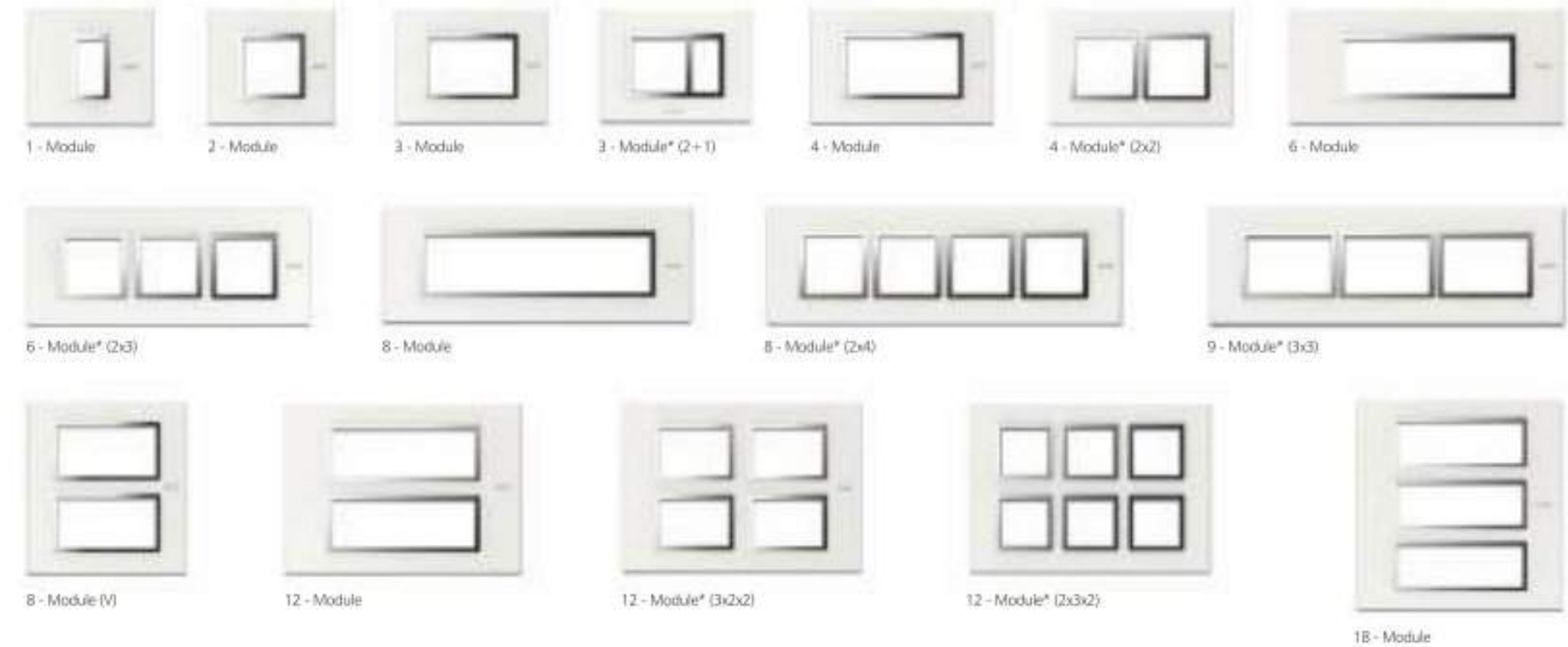

GRAZIA MOUNTING FRAMES - Horizontal & Vertical Distance for Screwing | Dimensions in mm |

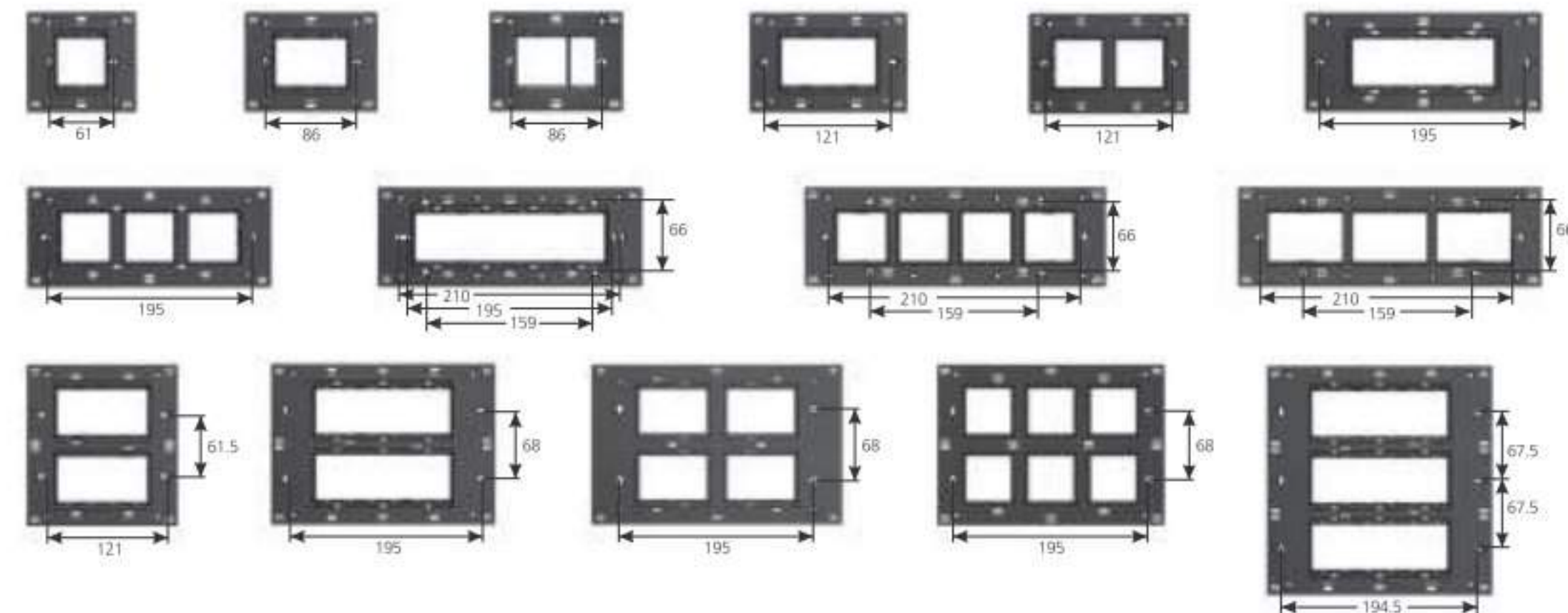



Classio Black Glossy Plate with Digital Silver I-touch Bellpush

GLASSIO

The Glassio is without doubt a classical beauty – exhibiting a smooth, glossy frontage, with soft, rounded edges and a demeanour that’s sophisticated yet warm and welcoming. The elegantly flared corners reflect and absorb light in a manner that adds depth and character to the cover plate. This interplay of light and shadow also creates a sinuous effect that makes Glassio the definitive artefact on your wall.

Classio Black Glossy Plate with Digital Silver RF I-touch Switches



GLASSIO COVER PLATES WITH MOUNTING FRAMES

PLATES →	1M	2M	3M	4M	4M*	6M	6M*	8M	8M*	8M	9M*	12M	12M*	16M*	18M
					(H&V)**		(H&V)**		(H&V)**	(V)				(H&V)**	
COLOURS ↓	MRP ₹	MRP ₹	MRP ₹	MRP ₹	MRP ₹	MRP ₹	MRP ₹	MRP ₹	MRP ₹	MRP ₹	MRP ₹	MRP ₹	MRP ₹	MRP ₹	MRP ₹
Pure Glossy	121.00	121.00	149.00	181.00	181.00	260.00	260.00	330.00	330.00	330.00	353.00	377.00	377.00	424.00	481.00
Metallic	163.00	163.00	213.00	260.00	260.00	355.00	355.00	445.00	445.00	445.00	480.00	522.00	522.00	586.00	626.00
Metal Krome	244.00	244.00	340.00	413.00	413.00	554.00	554.00	744.00	744.00	744.00	758.00	765.00	765.00	839.00	886.00
Wood	218.00	218.00	296.00	362.00	362.00	494.00	494.00	678.00	678.00	678.00	688.00	693.00	693.00	768.00	810.00
CODE →	120101	120201	120301	120401	120404	120601	120604	120801	120804	128801	120901	121201	121204	121601	121801
Outer/Master →	10/500	10/500	10/400	10/400	10/400	5/200	5/200	5/200	5/200	5/200	5/200	5/120	5/120	5/90	5/80
SIZE(mm) →	92x90	92x90	120x90	146x90	152x90	219x90	219x90	244x90	264x90	152x168	280x90	219x156	219x156	244x156	219x223

*With Partition Plates

**Suitable for Horizontal & Vertical Installation

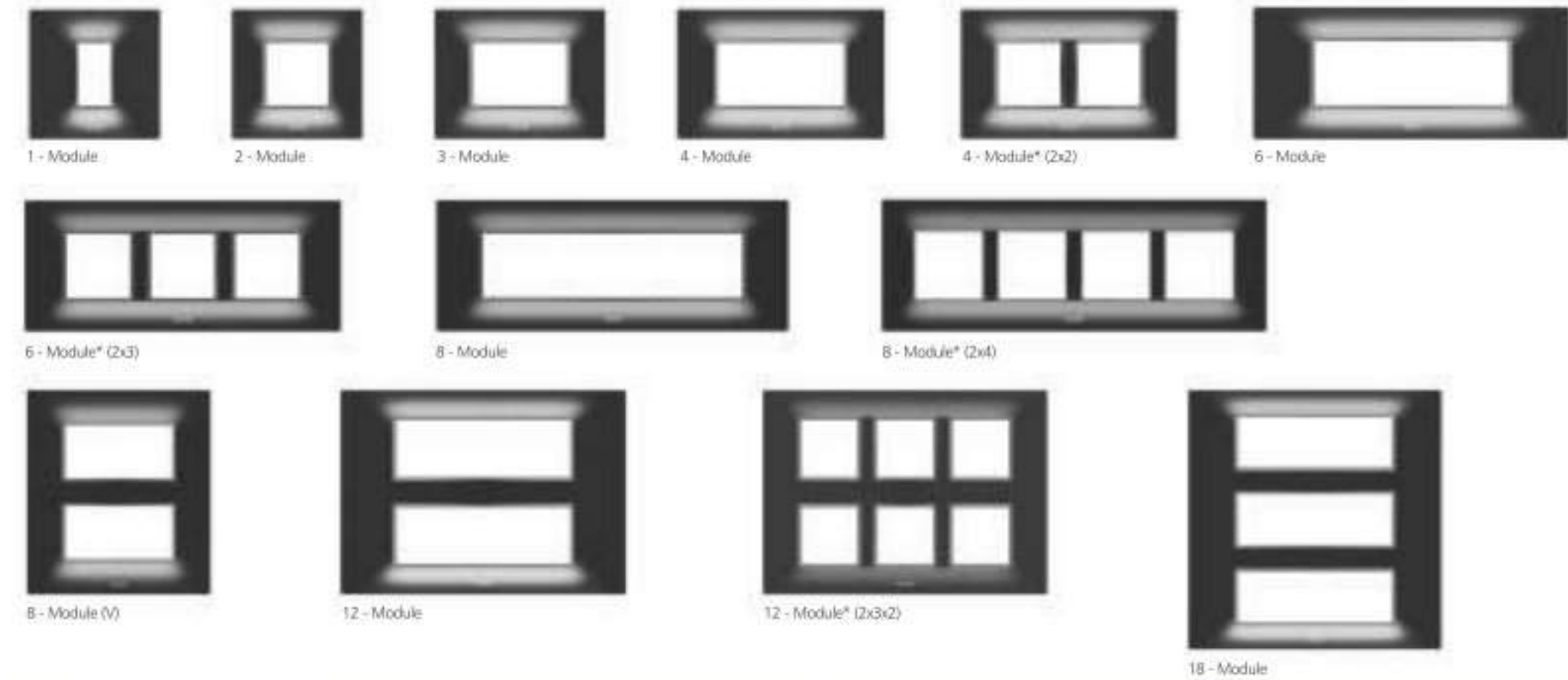

GLASSIO MOUNTING FRAMES - Horizontal & Vertical Distance for Screwing | Dimensions in mm |

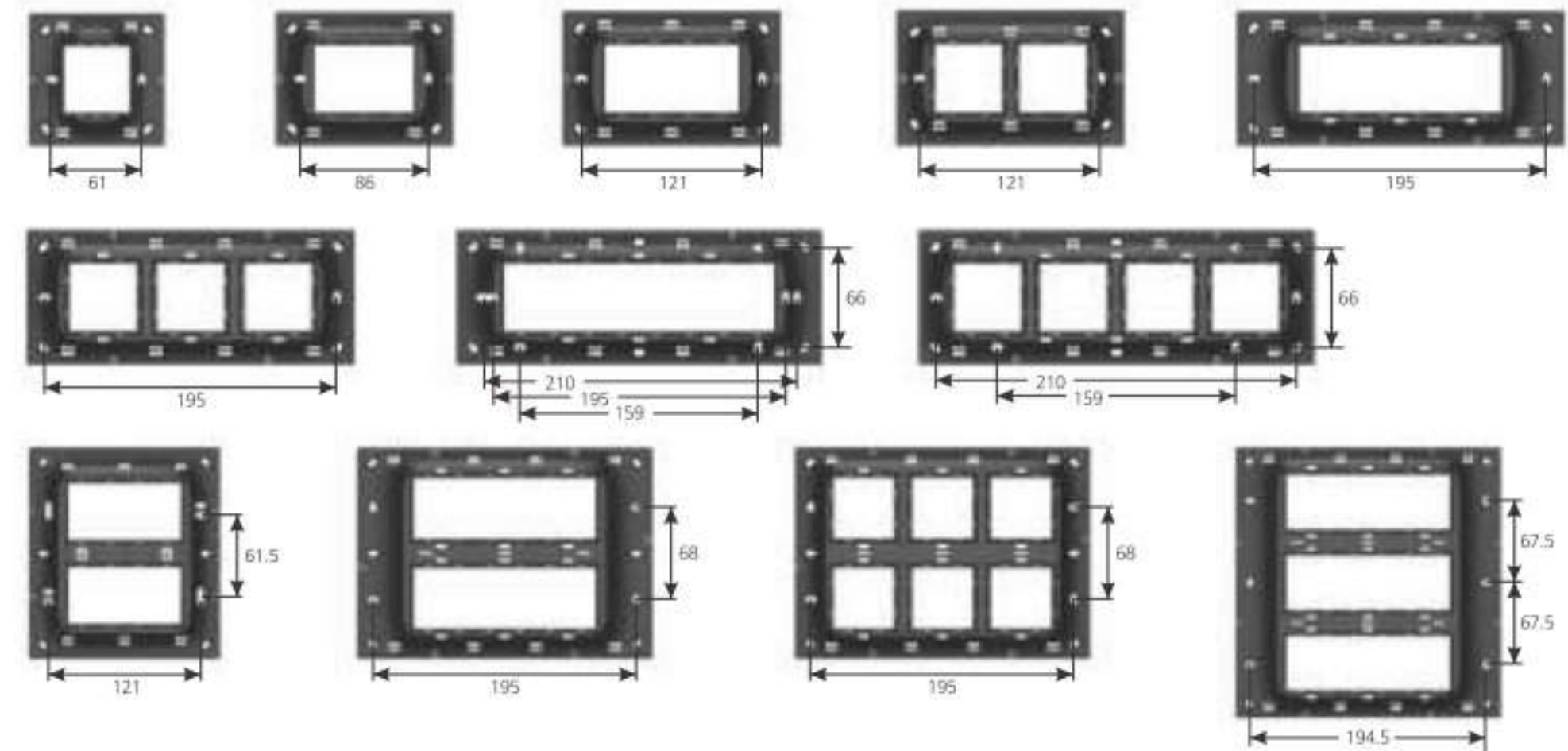



Wega Junglee Wenge Plate with Titanium Grey G-dip Switches

WEGA

Unconventional yet perfectly symmetrical, bold yet elegant - the Wega cover plates are stunning in every way. An example of imagination and engineering precision of the highest order, the Wega, with its distinctive appearance stands out from the clutter with ease. Its undulating shape creates a magical interplay of light that adds to its visual appeal. The colours appear dazzling, mesmerizing and even playful, depending on the prevailing light conditions.

Wega Dark Espresso Plate with Titanium Grey Step Marker



NEW

WEGA COVER PLATES WITH MOUNTING FRAMES

PLATES →	1M	2M	3M	4M	4M	6M	6M*	8M	8M*	8M	12M	16M	18M
					(H&V)**		(H&V)**		(H&V)**	(V)			
COLOURS ↓	MRP ₹	MRP ₹	MRP ₹	MRP ₹	MRP ₹	MRP ₹	MRP ₹	MRP ₹	MRP ₹	MRP ₹	MRP ₹	MRP ₹	MRP ₹
Pure Glossy	-	199.00	263.00	318.00	318.00	399.00	379.00	493.00	474.00	493.00	602.00	680.00	861.00
Metallic	-	299.00	349.00	424.00	424.00	487.00	467.00	598.00	580.00	598.00	852.00	930.00	1036.00
Wood	-	343.00	399.00	474.00	474.00	562.00	543.00	711.00	692.00	711.00	983.00	1190.00	1235.00
CODE →	200101	200201	200301	200401	200403	200601	200603	200801	200803	208801	201201	201601	201801
Outer/Master →	10/400	10/400	10/300	10/300	10/300	5/150	5/150	5/150	5/150	5/150	5/120	5/90	5/80
SIZE(mm) →	94x92	94x92	122x92	148x92	154x92	221x92	221x92	246x92	266x92	154x170	221x159	221x159	221x225

* With Partition Plates

** Suitable for Horizontal & Vertical Installation

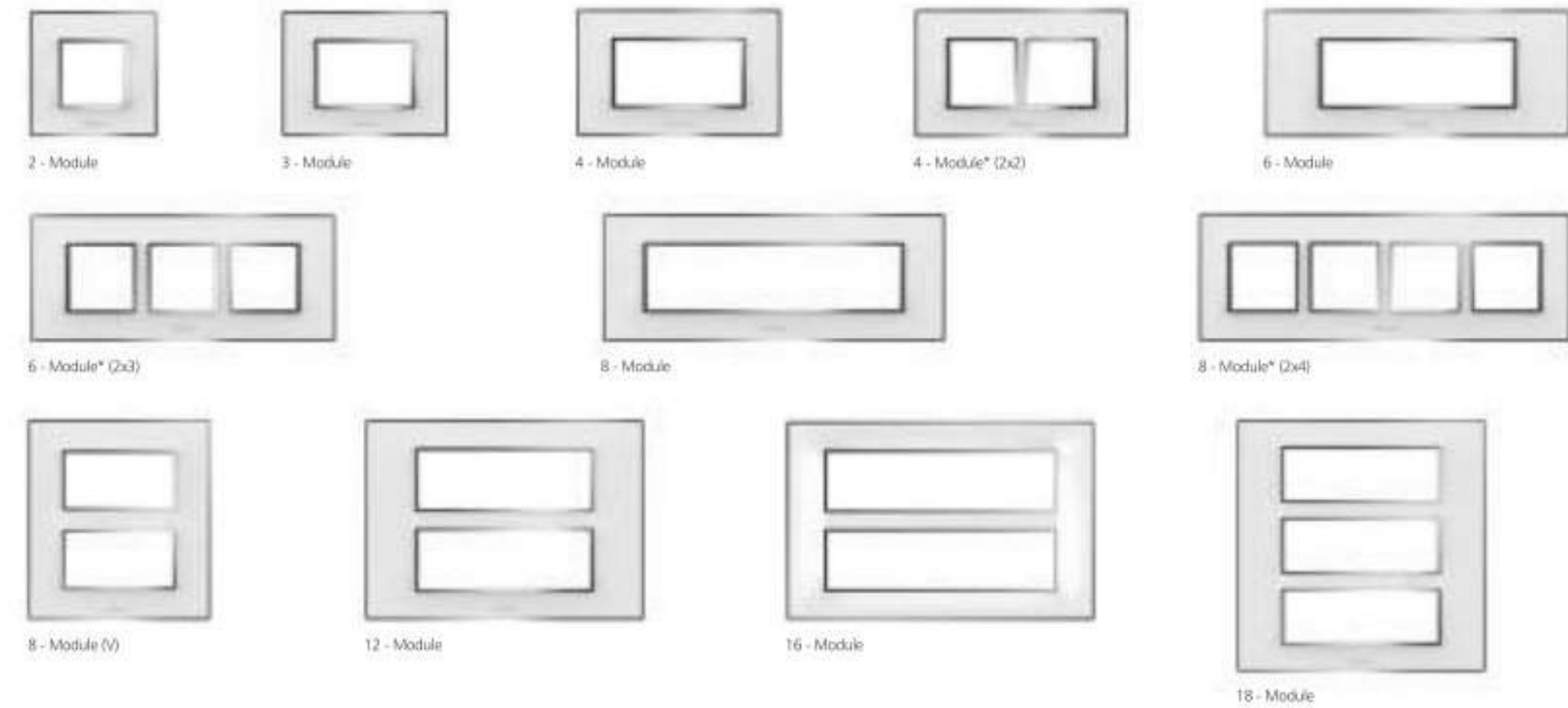

WEGA MOUNTING FRAMES - Horizontal & Vertical Distance for Screwing (Dimensions in mm)

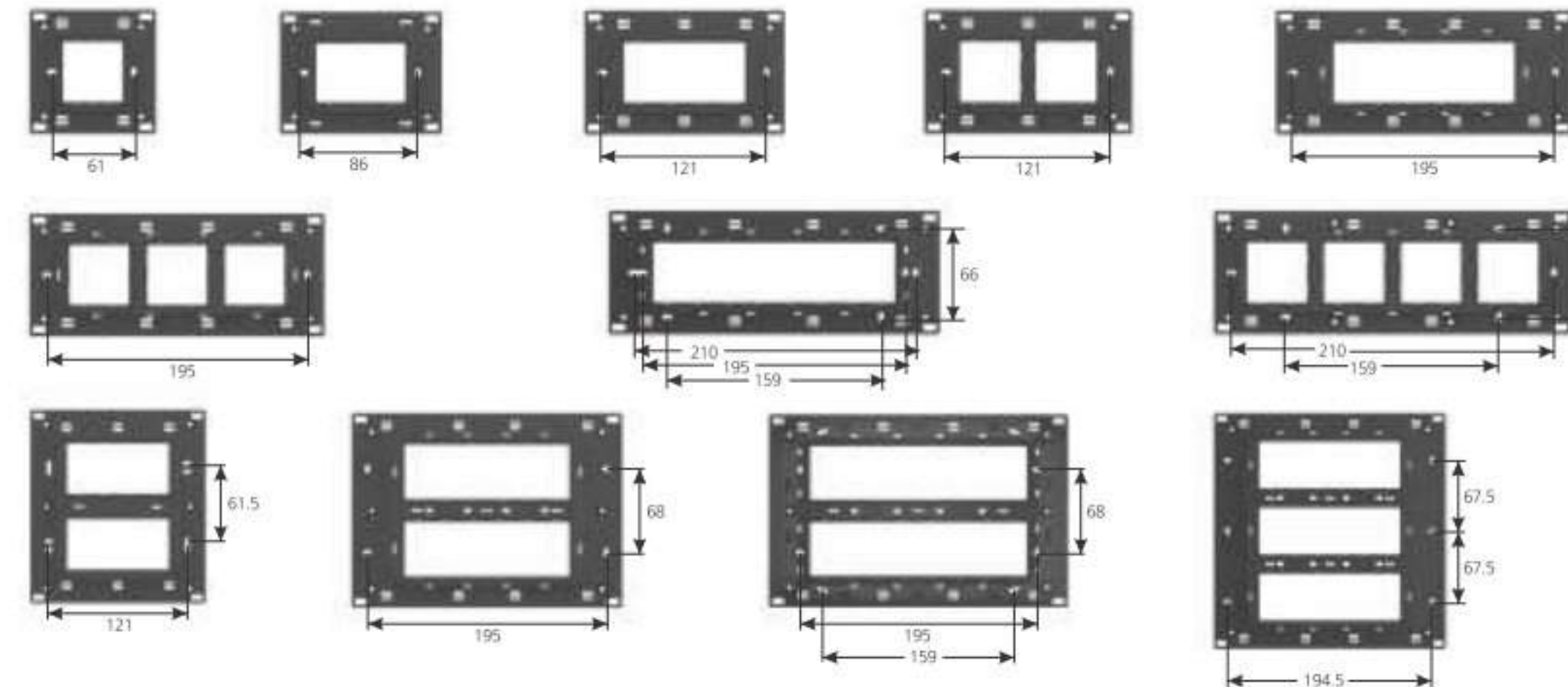

COLOURS OF COVER PLATES

PURE GLOSSY



01 - Absolute White

METALLIC



05 - Champagne Gold



06 - Titanium Silver



07 - Titanium Grey



08 - Atomic Blue



09 - Green Witch



10 - Nuclear Grey



11 - Purple Passion



12 - Red Fever



13 - Gaga Blue



14 - Lusty Ginger



12 - Puppy Brown

WOOD



11 - Jungle Wenge



12 - Dark Espresso



13 - Tom & Jerry



14 - Tortilla Wood

Colours shown may not match actual product colours due to printing limitations.

COLOURS OF COVER PLATES

bella

WHITE JAZZ



01 - White Jazz

METALIK



06 - Spirit Gold



07 - Silver Streak



08 - Copper

BELLESOFT



09 - Digital Chrome



16 - Pepper Leaf



17 - Deep Currant



18 - Blu Caspian

ANTI-K



21 - Voltage Grey



31 - Antik Copper



41 - African Wenge



44 - Burma Teak

WHITE JAZZ



01 - White Jazz

Cristallo

TWIXOS



12 - Valentine Wine



13 - Herbal Spa



14 - Plum Island



15 - Ice Grey

Metalik



21 - Ocean Pearl



22 - Gold



26 - Fumed Oak

Wood

Colours shown may not match actual product colours due to printing limitations.

COLOURS OF COVER PLATES

PURE GLOSSY



01 - Absolute White



02 - Black Glossy



03 - Ivory Gold

METALLIC



04 - Digital Chrome*

METAL KROME



05 - Hyper Chrome

WOOD



06 - Black Walnut



07 - Moughal Teak

grazia

PURE GLOSSY



01 - Absolute White

METALLIC



02 - Digital Silver

WOOD



03 - Italian Espresso



04 - Zebra Wood

premium

PURE GLOSSY



05 - Absolute White

COLOURS OF COVER PLATES

BASIC



16 - Satin White

METALLIC



17 - Digital Silver

BASIC WOOD



18 - Fumed Oak

basic

GLASS



21 - Snow White



22 - Red Wine



23 - Green Ice



24 - Rich Black

premium



25 - Hot Red

GLASS



41 - Mint Ice



42 - Honey Sapphire



45 - Magic Mirror



46 - Honey Mint

Crystalight



47 - Grey Ghost

XTREME



86 - Brushed Black



87 - Brushed Silver

Air

Flat. Flawless. Flamboyant.

Aero

Completely flat -
at OFF position

The Aero redefines flat switches. Styled to remain absolutely flush with the cover plate, the Aero emphasizes the minimalistic design of the Air range. Manufactured using the very best in raw materials and processes, the Aero is both functionally and aesthetically a class apart!



Arcos

Add a new dimension to your
interiors



The Arcos switch is the perfect blend of sophistication and minimalism. The subtly contoured body and the arched edges of the Arcos is what sets it apart from its contemporaries. It makes a distinctive style statement while adhering to Goldmedal's vision of crafting extraordinary, timeless, and truly amazing switches.

Artio

Simple, minimalistic and
completely flat -
at OFF position



Inspired by the immaculate perfection of a circle, the new Artio range of switches are beautiful yet minimalistic in appearance. The Artio switch range consists of either completely circular or a combination of straight and semi-circular switches embedded within a square frame. Once installed, these switches form perfectly flat, flawless, circles.

Aura

Perfect crisp lines that define
the Air range

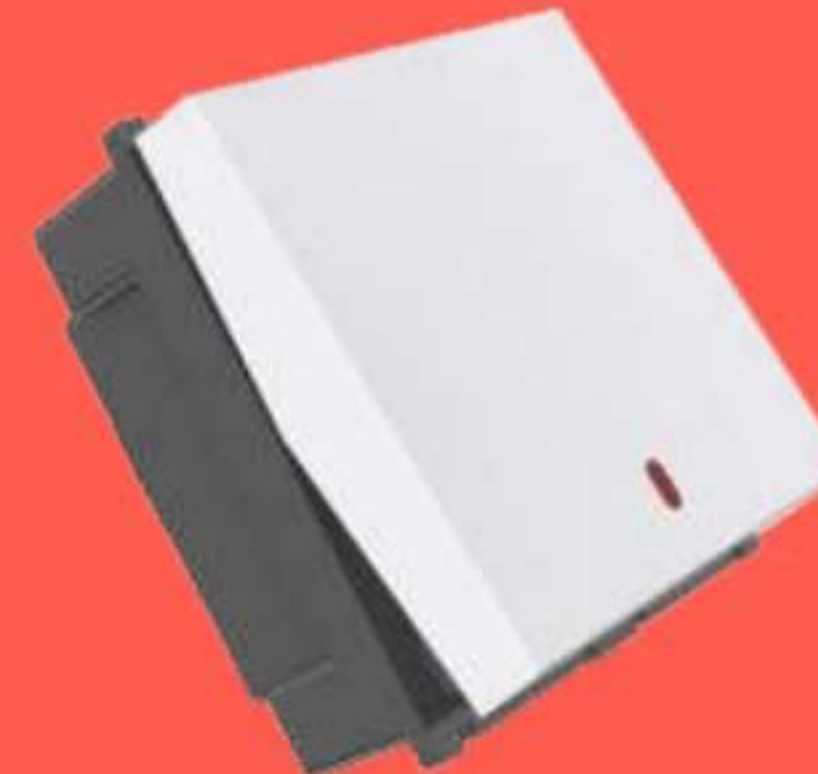

The Aura has a forceful presence that commands attention. With its perfect, crisp lines and distinct shape, the Aura highlights the precision and style that defines the Air range. The Aura is the perfect choice for interiors that are practical yet modern.

Arc

A symbol of elegant
minimalism



The Arc switches by Air symbolizes minimalist elegance. Easy on the eye as well as a pleasure to use, the Arc can be the perfect accessory in stylish homes with graceful settings. Crafted to perfection using the very best in technology and materials, the Arc adds a new dimension to your interiors.

Distinctly flat, slim and minimal

The AIR range of modular switches and systems breaks the mold with its classy, minimalistic, uniquely flat, and slim appearance. An example of meticulous craftsmanship, careful detailing, and unmatched excellence, the AIR range makes other ordinary switch ranges appear unwieldy and extravagant. Absolutely light and modern, the AIR range marks a new beginning in the world of standard fittings. Slim, stylish, minimal – the AIR devices shout quality, elegance, and finesse through every inch of their presence.



A7 Plate -
Arcos Switches with Indicator



A7 Plate -
Artio Switch with Indicator



A7 Plate -
Aero Switches with Indicator



A7 Plate -
USB Charger



A7 Plate -
Step Marker

A7 Plate -
i-Push Step Marker



A7 Plate -
Tri-Star 5 Step Regulator



A7 Plate -
Wi-Fi Switches



Code	Item	MRP ₹		Pkg.
		Absolute White	Carbon Grey	
AERO 10AX SWITCHES 240V- [1 Module]				
181001	1 Way Switch	66.00	72.00	20/600
181002	1 Way Switch with Ind. (LED)	114.00	125.00	20/600
181003	2 Way Switch	123.00	134.00	20/600
181004	Bell Push Switch	135.00	148.00	20/600
181005	Bell Push Switch with Ind. (LED)	152.00	167.00	20/600

Code	Item	MRP ₹		Pkg.
		Absolute White	Carbon Grey	
AERO 10AX SWITCHES 240V- [2 Module]				
182010	1 Way Switch	112.00	123.00	10/300
182011	1 Way Switch with Ind. (LED)	128.00	140.00	10/300
182012	2 Way Switch	180.00	198.00	10/300
182014	Bell Push Switch with Ind. (LED)	195.00	214.00	10/300

Code	Item	MRP ₹		Pkg.
		Absolute White	Carbon Grey	
AERO 20 / 25AMP SWITCHES 240V- [1 Module]				
181020	20A 1 Way Switch	155.00	170.00	20/600
181021	20A 1 Way Switch with Ind. (LED)	188.00	205.00	20/600
181022	20A 2 Way Switch	188.00	205.00	20/600
181023	25A 1 Way Switch	202.00	222.00	20/600

Code	Item	MRP ₹		Pkg.
		Absolute White	Carbon Grey	
AERO 20AMP SWITCHES 240V- [2 Module]				
182025	20A 1 Way Switch	194.00	213.00	10/300
182026	20A 1 Way Switch with Ind. (LED)	218.00	239.00	10/300
182027	20A 2 Way Switch	230.00	252.00	10/300

Code	Item	MRP ₹		Pkg.
		Absolute White	Carbon Grey	
AERO 32AMP DP SWITCH 240V- [2 Module]				
182031	32A DP Switch with Indicator (LED)	347.00	381.00	10/300

Code	Item	MRP ₹		Pkg.
		Absolute White	Carbon Grey	
ARC 10AX SWITCHES 240V- [1 Module]				
181401	1 Way Switch	61.00	67.00	20/600
181402	1 Way Switch with Ind. (LED)	107.00	117.00	20/600
181403	2 Way Switch	115.00	126.00	20/600
181404	Bell Push Switch	125.00	136.00	20/600
181405	Bell Push Switch with Ind. (LED)	140.00	154.00	20/600

Code	Item	MRP ₹		Pkg.
		Absolute White	Carbon Grey	
ARC 10AX SWITCHES 240V- [2 Module]				
182410	1 Way Switch	98.00	108.00	10/300
182411	1 Way Switch with Ind. (LED)	115.00	126.00	10/300
182412	2 Way Switch	162.00	178.00	10/300
182414	Bell Push Switch with Ind. (LED)	178.00	195.00	10/300

Code	Item	MRP ₹		Pkg.
		Absolute White	Carbon Grey	
ARC 20 / 25AMP SWITCHES 240V- [1 Module]				
181420	20A 1 Way Switch	141.00	155.00	20/600
181421	20A 1 Way Switch with Ind. (LED)	177.00	194.00	20/600
181422	20A 2 Way Switch	177.00	194.00	20/600
181423	25A 1 Way Switch	193.00	212.00	20/600

Code	Item	MRP ₹		Pkg.
		Absolute White	Carbon Grey	
ARC 20AMP SWITCHES 240V- [2 Module]				
182425	20A 1 Way Switch	171.00	188.00	10/300
182426	20A 1 Way Switch with Ind. (LED)	194.00	213.00	10/300
182427	20A 2 Way Switch	204.00	224.00	10/300

Code	Item	MRP ₹		Pkg.
		Absolute White	Carbon Grey	
ARC 32AMP DP SWITCH 240V- [2 Module]				
182431	32A DP Switch with Indicator (LED)	312.00	342.00	10/300





Code	Item	MRP ₹		Pkg. Outer/ Master
		Absolute White	Carbon Grey	
AURA 10AX SWITCHES 240V~ (1 Module)				
181501	1 Way Switch	61.00	67.00	20/600
181502	1 Way Switch with Ind. (LED)	107.00	117.00	20/600
181503	2 Way Switch	115.00	126.00	20/600
181504	Bell Push Switch	125.00	136.00	20/600
181505	Bell Push Switch with Ind. (LED)	140.00	154.00	20/600

Code	Item	MRP ₹		Pkg. Outer/ Master
		Absolute White	Carbon Grey	
AURA 10AX SWITCHES 240V~ (2 Module)				
182510	1 Way Switch	98.00	108.00	10/300
182511	1 Way Switch with Ind. (LED)	115.00	126.00	10/300
182512	2 Way Switch	162.00	178.00	10/300
182514	Bell Push Switch with Ind. (LED)	178.00	195.00	10/300

Code	Item	MRP ₹		Pkg. Outer/ Master
		Absolute White	Carbon Grey	
AURA 20 / 25AMP SWITCHES 240V~ (1 Module)				
181520	20A 1 Way Switch	141.00	155.00	20/600
181521	20A 1 Way Switch with Ind. (LED)	177.00	194.00	20/600
181522	20A 2 Way Switch	177.00	194.00	20/600
181523	25A 1 Way Switch	193.00	212.00	20/600

Code	Item	MRP ₹		Pkg. Outer/ Master
		Absolute White	Carbon Grey	
AURA 20AMP SWITCHES 240V~ (2 Module)				
182525	20A 1 Way Switch	171.00	188.00	10/300
182526	20A 1 Way Switch with Ind. (LED)	194.00	213.00	10/300
182527	20A 2 Way Switch	207.00	226.00	10/300

Code	Item	MRP ₹		Pkg. Outer/ Master
		Absolute White	Carbon Grey	
AURA 32AMP DP SWITCH 240V~ (2 Module)				
182531	32A DP Switch with Indicator (LED)	312.00	342.00	10/300

Code	Item	MRP ₹		Pkg. Outer/ Master
		Absolute White	Carbon Grey	
6AMP SOCKETS 240V~ (2 Module)				
182038	6A 3 Pin Socket with safety shutter	106.00	117.00	10/450

Code	Item	MRP ₹		Pkg. Outer/ Master
		Absolute White	Carbon Grey	
6&16AMP SOCKETS 240V~ (2 Module)				
182041	6&16A Universal Socket with safety shutter	219.00	240.00	10/450
182042	6&16A Universal Socket (Heavy Duty) with safety shutter	239.00	261.00	10/450
182043	6&16A Universal Raised Socket with safety shutter	219.00	240.00	10/450
182044	6&16A Universal Socket with flap, indicator & safety shutter (Suggested for without partition plate)	219.00	240.00	10/450

Code	Item	MRP ₹		Pkg. Outer/ Master
		Absolute White	Carbon Grey	
DIMMER / FAN REGULATOR 240V~ (1 Module)				
181045	Dimmer - 450W	276.00	302.00	20/600
181050	4 Step Regulator- Full Rotary	395.00	432.00	20/600
181051	4 Step Regulator (Regulator Supplied in ISI & Non ISI)	395.00	432.00	20/600

Code	Item	MRP ₹		Pkg. Outer/ Master
		Absolute White	Carbon Grey	
FULL ROTARY FAN REGULATOR 240V~ (2 Module)				
182049	8 Step Regulator - Full Rotary NEW	518.00	562.00	10/300
182052	Tri-Star 5 Step Regulator - Full Rotary	468.00	512.00	10/300
182053	Orion 5 Step Regulator - Full Rotary	468.00	512.00	10/300
182054	5 Step Regulator - Full Rotary (Regulator Supplied in ISI & Non ISI)	468.00	512.00	10/300

Code	Item	MRP ₹		Pkg. Outer/ Master
		Absolute White	Carbon Grey	
MOTOR STARTER (SP) 240V~ 50-60Hz (2 Module)				
182059	25A Motor Starter Switch	547.00	602.00	10/300

Code	Item	MRP ₹		Pkg. Outer/ Master
		Absolute White	Carbon Grey	
TV SOCKET / RJ-11 TELEPHONE JACKS / EDP SOCKET (1 Module)				
181062	TV Socket Coaxial 40-862 Mhz Socket	117.00	128.00	20/900
181068	Telephone Jack - RJ 11	124.00	136.00	20/600
181074	EDP Socket Outlet - RJ 45 (Cat 6e) Category 6e, Universal wiring T568A, insulating-piercing terminal.	572.00	629.00	20/600

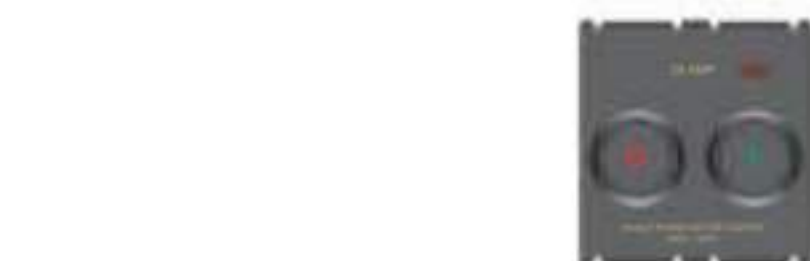
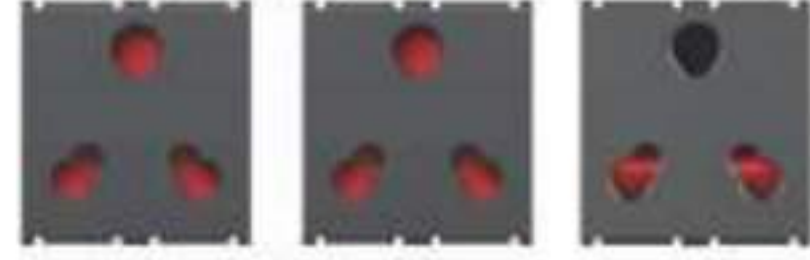

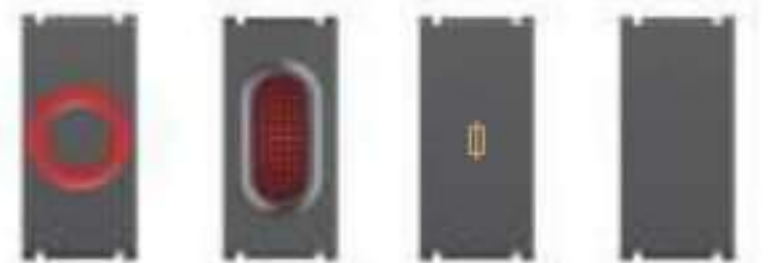

Code	Item	MRP ₹		Pkg.
		Absolute White	Carbon Grey	
32A NANO DP SWITCH 240V- (2 Module) NEW				
182076	32A DP Switch with Indicator (LED)	338.00	370.00	10/300
SINGLE POLE MCB 240/450V- (1 Module)				
181077	C6 SP MCB	324.00	357.00	20/600
181078	C10 SP MCB	324.00	357.00	20/600
181079	C16 SP MCB	324.00	357.00	20/600
181080	C20 SP MCB	324.00	357.00	20/600
181081	C25 SP MCB	324.00	357.00	20/600
181082	C32 SP MCB	324.00	357.00	20/600
240/450V- 50-60Hz 3kA Breaking Capacity				
DOUBLE POLE MCB 240/450V- (2 Module)				
182083	C6 DP MCB	670.00	737.00	10/300
182084	C10 DP MCB	670.00	737.00	10/300
182085	C16 DP MCB	670.00	737.00	10/300
182086	C20 DP MCB	670.00	737.00	10/300
182087	C25 DP MCB	670.00	737.00	10/300
182088	C32 DP MCB	670.00	737.00	10/300
240/450V- 50-60Hz 3kA Breaking Capacity				
INDICATOR / FUSE UNIT / BLANK MODULE (1 Module)				
181093	Indicator with LED & Red Diffuser	102.00	111.00	20/600
181094	Indicator with LED & Red Diffuser	102.00	111.00	20/600
181098	Fuse Carrier (10Amp/16Amp) with miniature fuse dia 6.3x28	142.00	155.00	20/600
181125	Blank Module	32.00	35.00	50/2000
STEP MARKER 240V-				
182105	Step Marker (2M)	564.00	615.00	10/300
182105WW	Step Marker (Warm White LED) (2M) Supply voltage 240V- 50-60Hz with high-efficiency 5x0.2W LED	564.00	615.00	10/300
183106	Step Marker (Warm White LED) (3M) Supply voltage 240V- 50-60Hz with high-efficiency 6x0.2W LED	669.00	731.00	5/100
ELECTRONIC BELL / 32A MAIN SWITCH 240V- (2 Module)				
182139	Electronic Bell 240V-50-60Hz	344.00	380.00	10/300
182163	32A DP Operated by Key Tag 240V-, LED Supplied with Key Tag	459.00	504.00	10/300
182164	Only Key Tag with Name Plate	102.00	112.00	100/2000
DND/MAKE MY ROOM (2 Module)				
182168	Do Not Disturb/Make My Room 240V- 50-60Hz - Inside Room	422.00	464.00	10/300
182169	Do Not Disturb/Make My Room 240V- 50-60Hz - Outside Room	452.00	497.00	10/300

Code	Item	MRP ₹		Pkg.
		Absolute White	Carbon Grey	
USB CHARGER 240V-				
182170	65W C-Type Fast Charger - Single Port (2M) Supply voltage 160-240V- 50-60Hz Output - PD USB Charger C type (Max 65W)	-	-	10/300
181171	USB Fast Charger - Single Port (1M) Supply voltage 160-240V- 50-60Hz Output - 5V=1.50A / 9V=1.45A, A type (Max 14W)	998.00	1097.00	10/300
182173	USB Charger with 2 USB Ports (2M) Supply voltage 160-240V- 50-60Hz Output - 5V DC, 2A, A type (Total)	966.00	1063.00	10/300
181175	18W C-Type Fast Charger - Single Port (1M) Supply voltage 160-240V- 50-60Hz Output - 5V=1.50A / 9V=1.45A USB Charger C type (Max 18W)	1418.00	1481.00	10/300
STEP MARKER 240V-				
184107	Footlight Step Marker (4M) Supply voltage 240V- 50-60Hz with high-efficiency 5x0.2W LED	800.00	876.00	5/120
182108	Push Step Marker (White LED) (2M) Supply voltage 240V- 50-60Hz with high-efficiency 2x0.5W LED	626.00	684.00	10/300
i-SMART WI-FI 6A SWITCHES				
181185*	i-Smart 6A Switch (1M)	1888.00	2071.00	5/100
182189*	i-Smart 6A 2 Switch (2M) Supply voltage 160-240V-, 6A relay output Operating load (CFL & LED): 100W Max (per switch) Wi-Fi : 2.4GHz	2465.00	2675.00	5/100
i-SMART WI-FI 20A SWITCH (2 Module)				
182190*	i-Smart 20A Switch Supply voltage 160-240V-, 20A relay output Operating load (CFL & LED): 200W Max Air conditioner: 1.5 ton Wi-Fi : 2.4GHz	2465.00	2675.00	5/100
i-SMART WI-FI DIMMER/FAN REGULATOR (2 Module)				
182192*	i-Smart Dimmer Supply voltage 160-240V-, Triac Technology with soft end & soft start function Operating load (LED) : 80W (Max) Incandescent Light: 40-450W Wi-Fi : 2.4GHz Not suitable for Fan	3410.00	3725.00	5/100
182196*	i-Smart Fan Regulator Supply voltage 160-240V- Variable Capacitance based 5 step regulator Operating load (Fan) : 100W Wi-Fi : 2.4GHz Can also be operated via i-World App, Google Home & Alexa	3725.00	4093.00	5/100
i-SMART WI-FI PANEL 240V- (4 Module) NEW				
184204	i-Smart - WiFi 4 Switch + Fan Reg. + 1 USB Port C Type (With Glass Plate) Supply voltage 160-240V-, 6A relay output Operating load (CFL & LED): 100W Max (per switch) Radio Frequency : 433.92 MHz Variable Capacitance based 5 Step Fan Regulator USB Output: 5V=1.50A / 9V=1.45A (Max 18W)	-	-	5/-

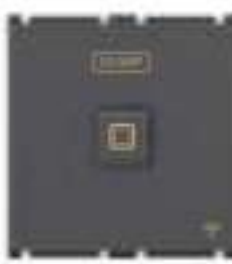



ARTIO

The Artio is a delightfully simple and minimalistic expression of the Air range. Embodying reductionism and refinement, which are hallmarks of a sleek, modern, and urbane lifestyle, the Artio makes a contemporary statement in every sense. Embedded within a square frame, the Artio switches can be installed as a single switch or as a combination of multiple switches to form a complete circle. The elegance, harmony and compositional unity that Artio represents gives it a truly timeless appeal.

Air A7 Absolute White Plate with Carbon Grey Artio Switch



Code	Item	MRP ₹		Pkg. Outer/ Master
		Absolute White	Carbon Grey	
ARTIO 10AX SWITCHES 240V- (2 Module)				
182301	1 Way Switch (2 Switch)	108.00	119.00	10/300
182303	2 Way Switch (2 Switch)	175.00	193.00	10/300
182306	1 Way Switch (3 Switch)	145.00	160.00	10/300
182307	1 Way + 2 Way Switch (2 Switch)	141.00	155.00	10/300
ARTIO 10AX SWITCHES 240V- (2 Module)				
182310	1 Way Switch (1 Switch)	98.00	108.00	10/300
182312	2 Way Switch (1 Switch)	154.00	169.00	10/300
182313	Bell Push Switch (1 Switch)	126.00	139.00	10/300
ARTIO 10AX / 20AMP SWITCHES 240V- (2 Module)				
182320	20A 1 Way Switch (2 Switch)	190.00	209.00	10/300
182321	20A 1 Way Switch with Indicator - LED (2 Switch)	240.00	264.00	10/300
182324	10AX + 20A 1 Way Switch with Indicator - LED (2 Switch)	199.00	219.00	10/300
ARTIO 20AMP SWITCHES 240V- (2 Module)				
182325	20A 1 Way Switch (1 Switch)	165.00	182.00	10/300
182326	20A 1 Way Switch with Indicator - LED (1 Switch)	195.00	215.00	10/300
ARTIO 32AMP DP SWITCH 240V- (2 Module)				
182331	32A DP Switch with Indicator (LED)	310.00	341.00	10/300





Air A5 Absolute White Plate with Carbon Grey Arcos Switches

ARCOS

The Arcos switch is the perfect blend of sophistication and minimalism, thus encapsulating the signature design of the Air modular range. Like its contemporary Artio, the Arcos too fits seamlessly within the slot of the Air cover plates. The subtly contoured body and the arched edges of the Arcos separates it from the more austere shape of the Artio. Perfectly proportioned, the Arcos makes a distinctive style statement while adhering to Goldmedal's vision of crafting extraordinary, timeless, and truly amazing switches.

Air A5 Absolute White Plate with Carbon Grey Arcos Switch



Code	Item	MRP ₹		Pkg. Outer/ Master
		Absolute White	Carbon Grey	
ARCOS 10AX SWITCHES 240V- [2 Module]				
182601*	1 Way Switch (2 Switch)	103.00	113.00	10/300
182603*	2 Way Switch (2 Switch)	170.00	187.00	10/300
182606*	1 Way Switch (3 Switch)	140.00	154.00	10/300
182607*	1 Way + 2 Way Switch (2 Switch)	137.00	151.00	10/300

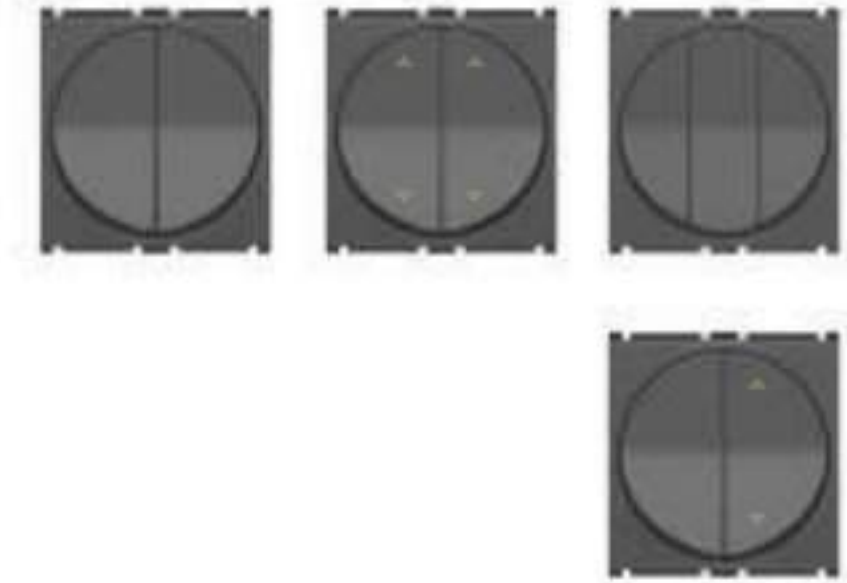

Code	Item	MRP ₹		Pkg. Outer/ Master
		Absolute White	Carbon Grey	
ARCOS 10AX SWITCHES 240V- [2 Module]				
182610*	1 Way Switch (1 Switch)	93.00	102.00	10/300
182612*	2 Way Switch (1 Switch)	149.00	164.00	10/300
182613*	Bell Push Switch (1 Switch)	121.00	133.00	10/300



Code	Item	MRP ₹		Pkg. Outer/ Master
		Absolute White	Carbon Grey	
ARCOS 10AX/ 20AMP SWITCHES 240V- [2 Module]				
182620*	20A 1 Way Switch (2 Switch)	185.00	204.00	10/300
182621*	20A 1 Way Switch with Indicator - LED (2 Switch)	235.00	259.00	10/300
182624*	10AX + 20A 1 Way Switch with Indicator - LED (2 Switch)	194.00	213.00	10/300



Code	Item	MRP ₹		Pkg. Outer/ Master
		Absolute White	Carbon Grey	
ARCOS 20AMP SWITCHES 240V- [2 Module]				
182625*	20A 1 Way Switch (1 Switch)	160.00	176.00	10/300
182626*	20A 1 Way Switch with Indicator - LED (1 Switch)	190.00	209.00	10/300



Code	Item	MRP ₹		Pkg. Outer/ Master
		Absolute White	Carbon Grey	
ARCOS 32AMP DP SWITCH 240V- [2 Module]				
182631*	32A DP Switch with Indicator (LED)	299.00	329.00	10/300



* introducing shortly



Air A3 Carbon Grey Plate with Carbon Grey Aero Switch, Orion Regulator

A3

If you thought practical was dull and boring then you've been looking at the wrong designs. The A3 cover plates will surprise you with their unique combination of practical utility and premium look. Super slim, flat, yet extremely durable, the A3 modular cover plates can easily be the first choice for modern interiors. The distinctive chrome border raises the style quotient of these plates to a higher level! So say yes to practical style that's never boring!

Air A3 Carbon Grey Plate with Carbon Grey Aero Switch, Tri-Star Regulator



A3 COVER PLATES WITH MOUNTING FRAMES

PLATES →	1M	2M	3M	3M*	4M	4M*	6M	6M*	8M	8M*	8M*	12M*	16M	18M	18M*
						(H&V)**		(H&V)**		(H&V)**	(V)**	(H&V)**			(H&V)**
COLOURS ↓	MRP ₹	MRP ₹	MRP ₹	MRP ₹	MRP ₹	MRP ₹	MRP ₹	MRP ₹	MRP ₹	MRP ₹	MRP ₹	MRP ₹	MRP ₹	MRP ₹	MRP ₹
Pure Glossy	96.00	96.00	128.00	128.00	157.00	157.00	236.00	213.00	325.00	290.00	290.00	346.00	372.00	487.00	426.00
Metallic	120.00	120.00	160.00	160.00	196.00	196.00	295.00	266.00	406.00	363.00	363.00	433.00	465.00	609.00	533.00
CODE →	180101	180201	180301	180303	180401	180403	180601	180603	180801	180803	188803	181203	181601	181801	181803
Outer/Master →	10/500	10/500	10/400	10/400	10/400	10/400	5/200	5/200	5/200	5/200	5/200	5/120	5/90	5/80	5/80
SIZE(mm) →	98x91	98x91	121x91	121x91	152x91	152x91	220x91	220x91	245x91	245x91	152x168	220x157	245x157	220x222	220x222

* With Partition Plates ** Suitable for Horizontal & Vertical Installation

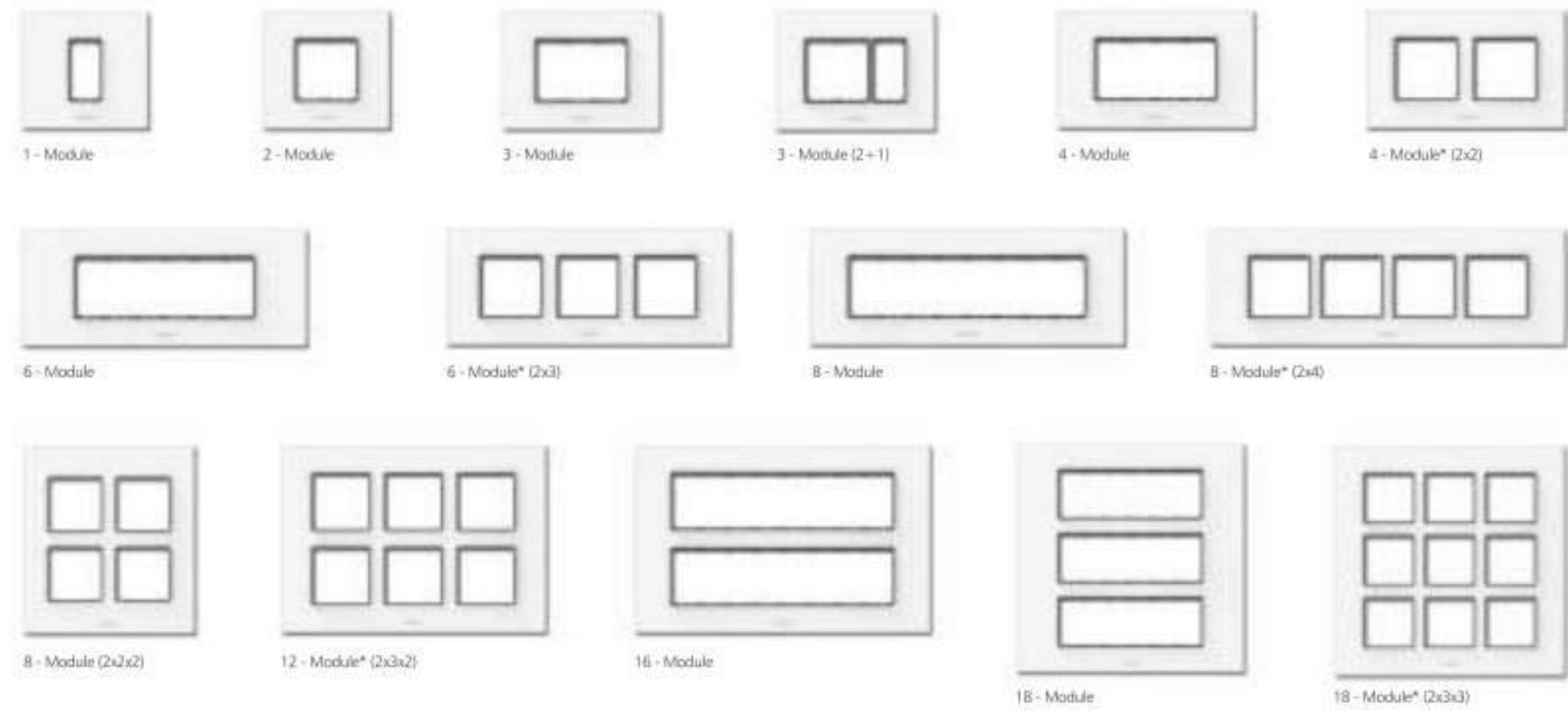

A3 MOUNTING FRAMES - Horizontal & Vertical Distance for Screwing (Dimensions in mm)

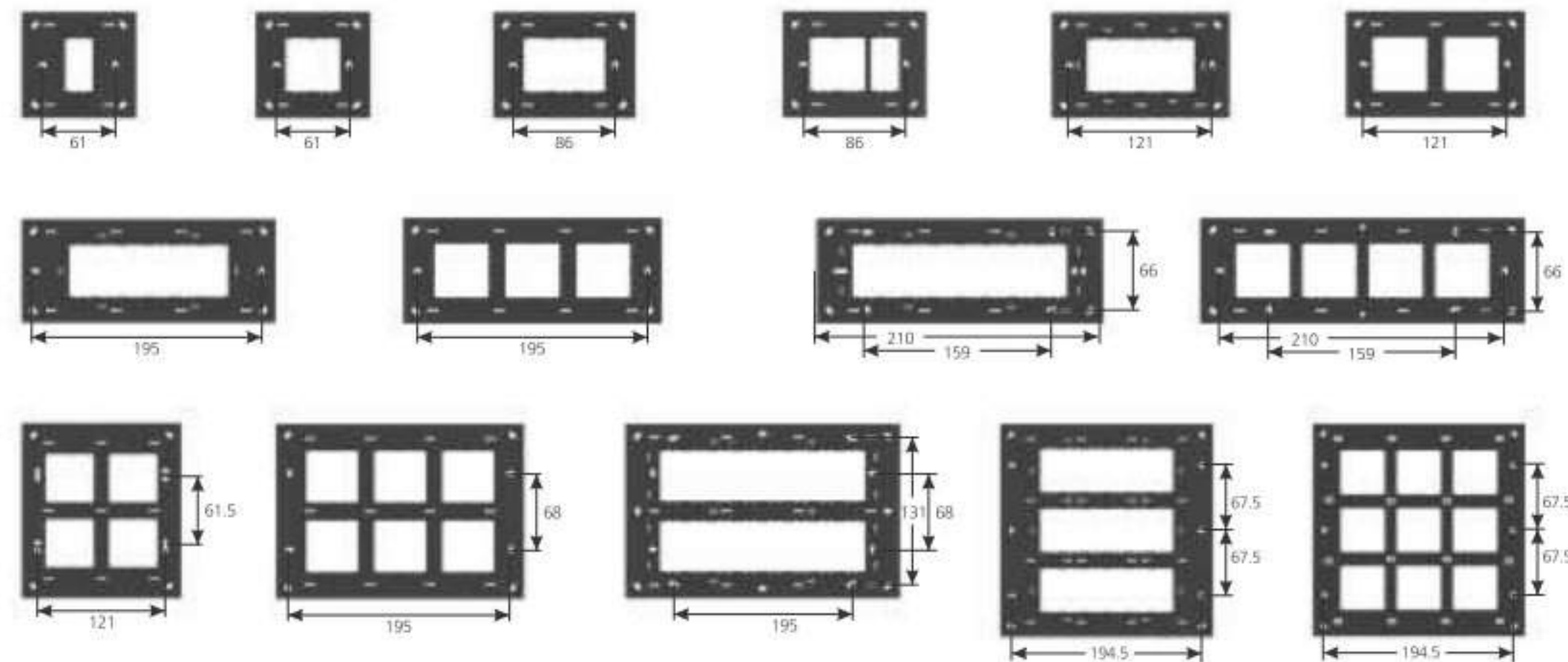



Air A5 Absolute White Plate with Aero Carbon Grey Switches

A5

The new A5 cover plate is a mix of playful elegance and contemporary styling. Gently curved with rounded corners and a sleek chrome border around the inner frame, the A5 is a refreshingly clean and modern design with a dash of added fun. Like other AIR cover plates, the A5 is restrained in a quiet, refined manner without being dull and boring. Introduce A5 to your interiors to exhibit that rare combination of elegance and charming playfulness!

Air A5 Absolute White Plate With Carbon Grey Arc Switch, Regulator



A5 BASIC COVER PLATES WITH MOUNTING FRAMES

PLATES →	1M	2M	3M	4M	4M*	6M	6M*	8M	8M*	8M*	12M*	16M	18M	18M*
					(H&V)**		(H&V)**		(H&V)**	(V)**	(H&V)**			(H&V)**
COLOURS ↓	MRP ₹	MRP ₹	MRP ₹	MRP ₹	MRP ₹	MRP ₹	MRP ₹	MRP ₹	MRP ₹	MRP ₹	MRP ₹	MRP ₹	MRP ₹	MRP ₹
Pure Glossy	86.00	86.00	112.00	138.00	138.00	210.00	186.00	283.00	251.00	251.00	320.00	351.00	425.00	370.00
Metallic	108.00	108.00	140.00	173.00	173.00	263.00	233.00	354.00	314.00	314.00	400.00	439.00	531.00	463.00

A5 PREMIUM COVER PLATES WITH MOUNTING FRAMES

Pure Glossy	90.00	90.00	118.00	146.00	146.00	220.00	198.00	303.00	270.00	270.00	330.00	369.00	452.00	397.00
CODE →	220101	220201	220301	220401	220403	220601	220603	220801	220803	228803	221203	221601	221801	221803
Outer/Master →	10/500	10/500	10/400	10/400	10/400	5/200	5/200	5/200	5/200	5/200	5/120	5/90	5/80	5/80
SIZE(mm)→	98x91	98x91	121x91	152x91	152x91	220x91	220x91	245x91	245x91	152x168	220x157	245x157	220x222	220x222

* With Partition Plates

** Suitable for Horizontal & Vertical Installation

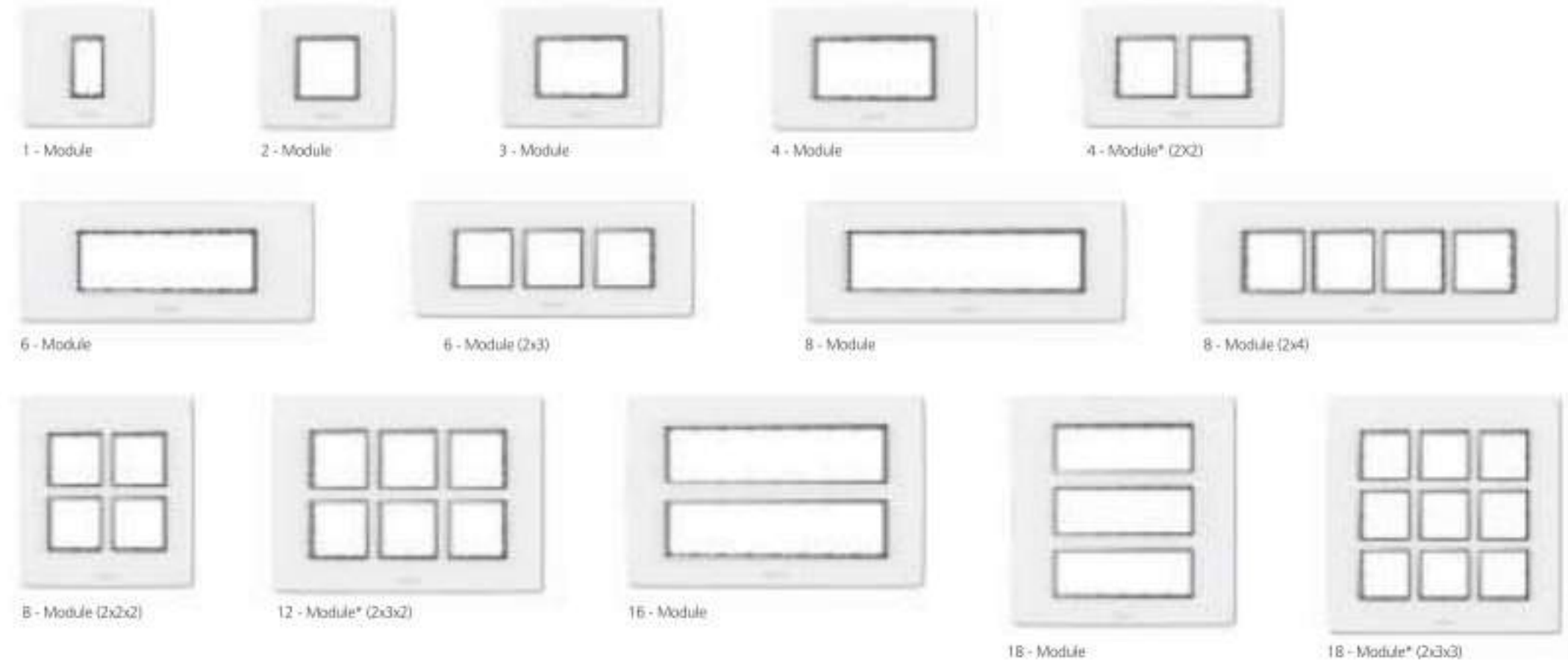

A5 MOUNTING FRAMES - Horizontal & Vertical Distance for Screwing (Dimensions in mm)

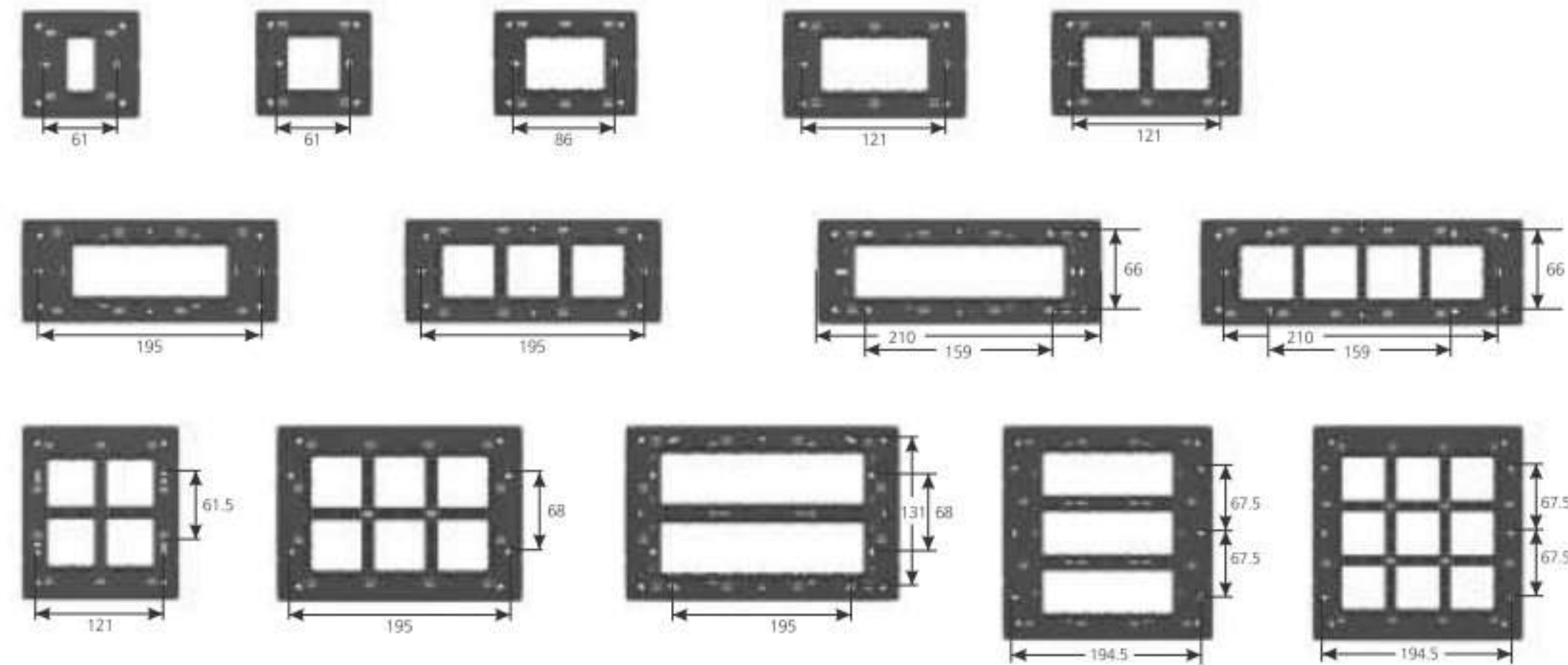



Air A7 Atomic Blue Plate with Carbon Grey Wi-Fi Switch, Regulator

A7

The AIR A7 cover plate is a wonderful combination of contemporary minimalistic design and stylish elegance. This is an ultra-flat plate with softly rounded corners and sleek chrome border around the inner frame. Characterised by AIR's familiar austere yet charming looks, the A7 offers a quiet and reserved presence without appearing mundane or boring. A quintessential modern-day switch plate, the A7 adds a touch of luxury with convincing functionality to every setting.

Air A7 Green Wtch Plate With Carbon Grey Aero Switch, Step Marker



A7 PREMIUM COVER PLATES WITH MOUNTING FRAMES

PLATES →	1M	2M	3M	3M*	4M	4M*	6M	6M*	8M	8M*	8M*	12M*	16M	18M*
						(H&V)**		(H&V)**		(H&V)**	(V)**	(H&V)**	(H&V)**	(H&V)**
COLOURS ↓	MRP ₹	MRP ₹	MRP ₹	MRP ₹	MRP ₹	MRP ₹	MRP ₹	MRP ₹	MRP ₹	MRP ₹	MRP ₹	MRP ₹	MRP ₹	MRP ₹
Pure Glossy	90.00	90.00	118.00	118.00	146.00	146.00	220.00	204.00	303.00	270.00	270.00	330.00	369.00	397.00
Metallic	113.00	113.00	148.00	148.00	183.00	183.00	275.00	255.00	379.00	338.00	338.00	413.00	461.00	496.00
CODE →	230101	230201	230301	230303	230401	230403	230601	230603	230801	230803	238803	231203	231603	231803
Outer/Master →	10/500	10/500	10/400	10/400	10/400	10/400	5/200	5/200	5/200	5/200	5/200	5/120	5/90	5/80
SIZE(mm) →	98x91	98x91	123x91	123x91	152x91	152x91	225x91	225x91	250x91	275x91	152x168	225x158	275x158	225x225

* With Partition Plates ** Suitable for Horizontal & Vertical Installation

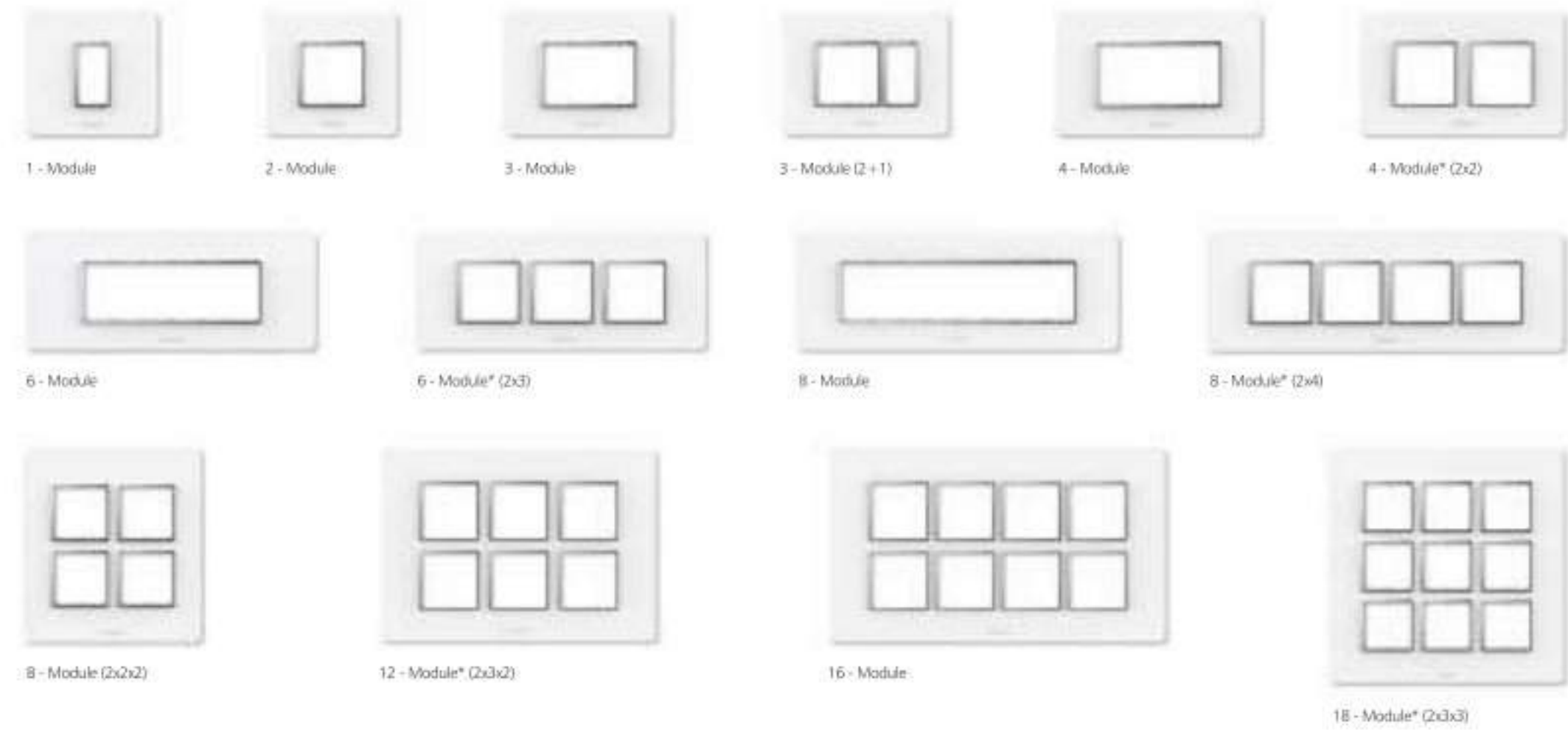

A7 MOUNTING FRAMES - Horizontal & Vertical Distance for Screwing [Dimensions in mm]

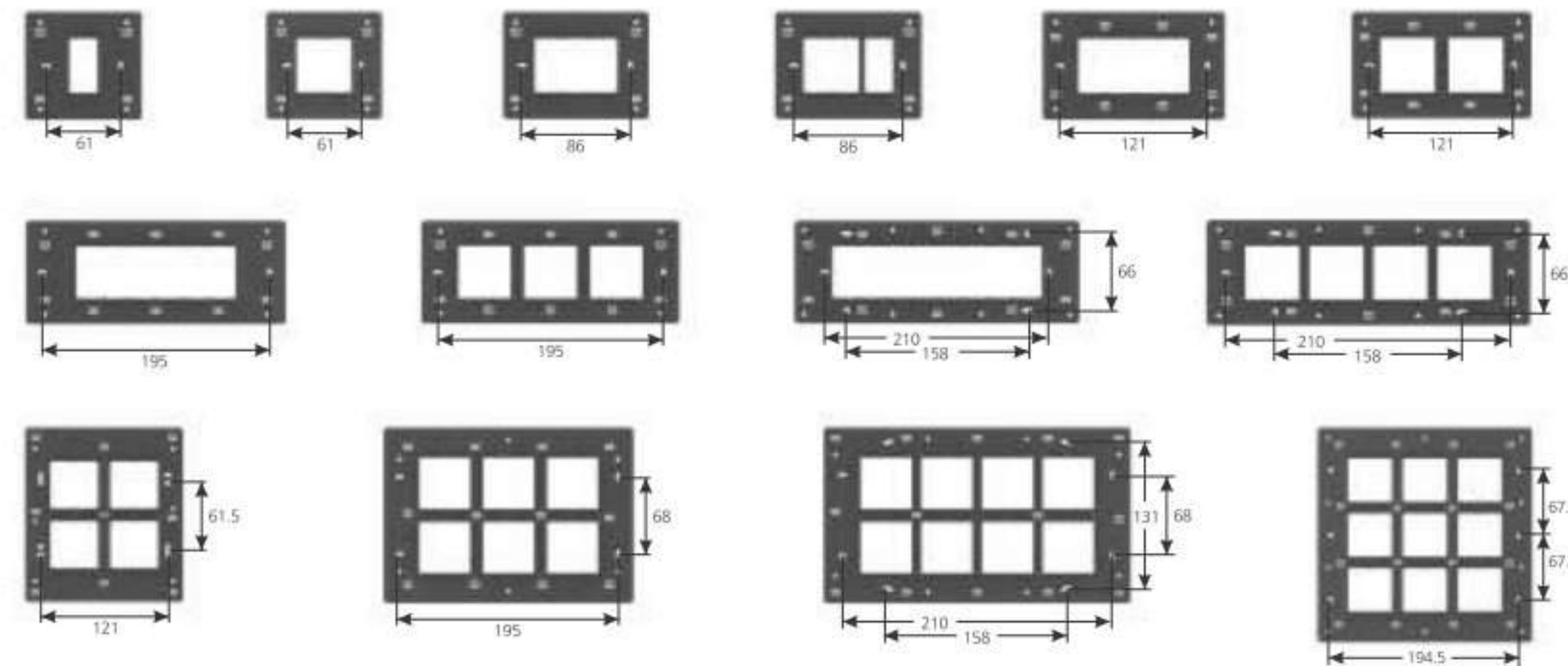

A6 WOODEN MODULAR PLATES - SUITABLE FOR WOODEN & METAL BOXES

PLATES	1M	2M	3M	4M	4M*	6M	6M*	6M	8M*
					(H&V)**		(H&V)**		(V)
COLOURS	MRP ₹	MRP ₹	MRP ₹	MRP ₹	MRP ₹	MRP ₹	MRP ₹	MRP ₹	MRP ₹
Pure Glossy	108.00	108.00	134.00	181.00	163.00	251.00	233.00	251.00	299.00
Metallic	168.00	168.00	207.00	278.00	257.00	385.00	360.00	385.00	459.00
Wood	206.00	206.00	257.00	346.00	311.00	479.00	448.00	479.00	573.00
CODE	190101	190201	190301	190401	190403	190601	190603	190605	198803
Outer/Master	10/300	10/300	10/300	10/240	10/240	10/200	10/200	10/200	5/200
SIZE(inch)	4.5x4.5	4.5x4.5	4.5x4.5	4.5x6.5	4.5x7.5	4.5x8.5	4.5x8.5	4.5x8.5	6.5x6.5
Module Format	-	-	-	-	2x2	-	2x3	3x2	2x2x2

*With Partition Plates **Suitable for Horizontal & Vertical Installation

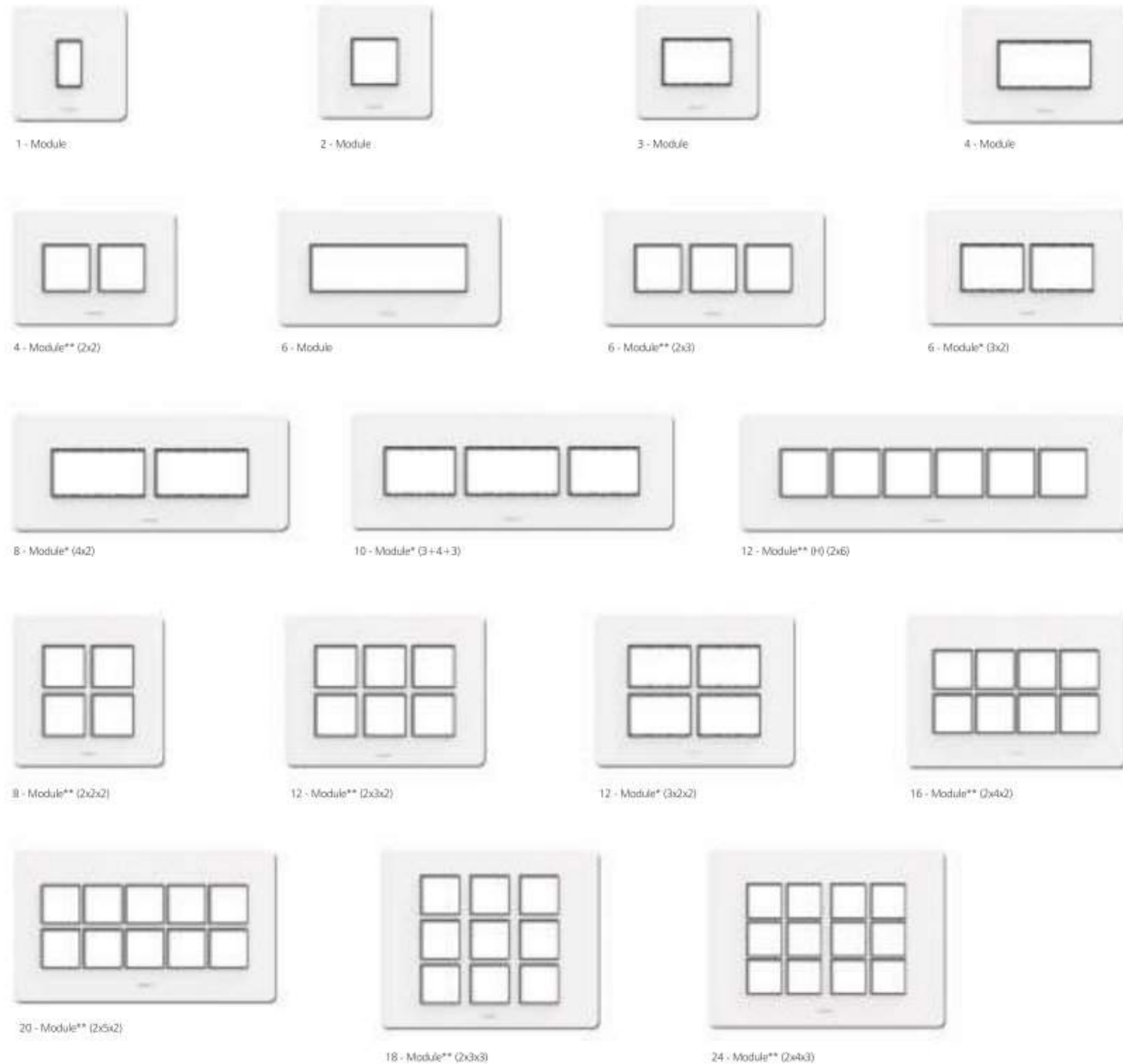

A6 WOODEN MODULAR PLATES - SUITABLE FOR WOODEN & METAL BOXES

8M*	10M	12M*	12M	12M	16M*	18M*	20M*	24M*
	(H)*	(H&V)**	(V)**	(V)*	(H&V)**	(H&V)**	(H&V)**	(H&V)**
MRP ₹	MRP ₹	MRP ₹	MRP ₹	MRP ₹	MRP ₹	MRP ₹	MRP ₹	MRP ₹
299.00	350.00	394.00	450.00	394.00	429.00	505.00	631.00	780.00
459.00	537.00	606.00	692.00	606.00	661.00	774.00	971.00	1203.00
573.00	670.00	758.00	862.00	758.00	823.00	964.00	1210.00	1501.00
190805	191001	191201	191203	191205	191601	191801	192001	192401
10/200	10/120	10/120	5/120	5/120	5/90	5/80	5/60	5/40
4.5x10.5	4.5x12.5	4.5x15.5	6.5x8.5	6.5x8.5	7.5x10.5	8.5x10.5	7.5x12.5	9.5x12.5
4x2	3+4+3	2x6	2x3x2	3x2x2	2x4x2	2x3x3	2x5x2	2x4x3

*With Partition Plates **Suitable for Horizontal & Vertical Installation

A6 MOUNTING FRAMES - Horizontal & Vertical Distance for Screwing (Dimensions in mm)

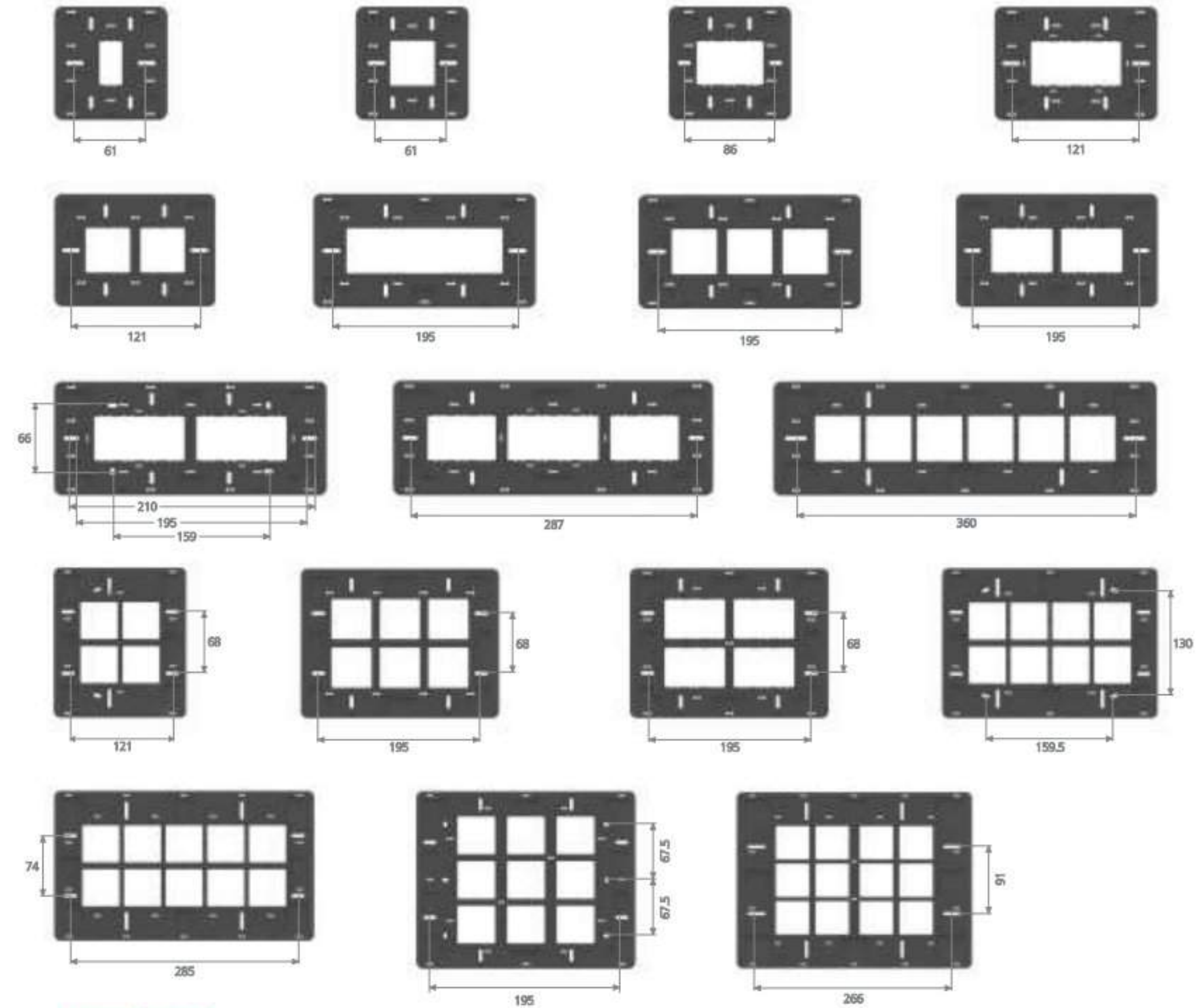

Not Suitable for Metal Box



Define your world with colours

**A3
PLATES**

PURE GLOSSY



01- Absolute White

METALLIC



01- Carbon Grey

**A5
PLATES**

BASIC - PURE GLOSSY



01- Absolute White

PREMIUM - PURE GLOSSY



01- Absolute White

**A7
PLATES**

PREMIUM - PURE GLOSSY



01- Absolute White

**A6
PLATES**

PREMIUM - PURE GLOSSY



01- Absolute White

METALLIC



07- Titanium Grey

WOOD



21- Volcanic Ash



22- Coffee Magic



23- Wild Wenge

* Colours shown may not match actual product colours due to printing limitations

Powering your
switchboard.
safely.



FLUSH MOUNTING METAL GANG BOX

Compact, resilient and sturdy, the Goldmedal metal gang boxes are the ideal enclosures for your switchboard accessories. Available in galvanised and 304 grade stainless steel options, these metal gang boxes securely hold all electrical wires and components in place without any additional support. While the galvanised metal boxes are corrosion-resistant, the stainless steel metal boxes are rust-free, easy to clean, and extremely strong and durable. With their simple yet robust design, these mounting boxes play a passive but invaluable role in ensuring that your electrical devices perform to their optimum without any interruption!

ECO FLUSH MOUNTING METAL GANG BOXES (GALVANIZED)

GANG BOX →	1 & 2M	3M	4M	6M	8M(H)	8M(V)	12M	16M	18M
MRP ₹ ↓	70.00	92.00	114.00	142.00	185.00	185.00	232.00	284.00	326.00
CODE	310201	310302	310403	310604	310805	318806	311207	311608	311809
Outer/Master	120	120	120	80	80	60	45	40	40
SIZE (WxHxL) mm	75x73x51	100x73x51	135x73x51	208x73x51	230x73x51	135x130x60	209x130x60	230x144x60	209x200x60

METAL GANG BOXES



PREMIUM FLUSH MOUNTING GANG BOXES (STAINLESS STEEL)

GANG BOX →	1 & 2M	3M	4M	6M	8M(H)	8M(V)	12M	16M	18M
MRP ₹ ↓	-	-	-	-	-	-	-	-	-
CODE	320201	320302	320403	320604	320805	328806	321207	321608	321809
Outer/Master	10/120	10/120	10/120	5/80	5/80	5/60	5/45	5/40	5/40
SIZE (WxHxL) mm	75x73x51	100x73x51	135x73x51	208x73x51	230x73x51	135x130x60	209x130x60	230x144x60	209x200x60

STAINLESS STEEL GANG BOXES



FLUSH MOUNTING METAL GANG BOXES (GALVANIZED)

GANG BOX →	1 & 2M	3M	4M	6M	8M(H)	8M(V)	12M	16M	18M
MRP ₹ ↓	78.00	102.00	127.00	158.00	205.00	205.00	258.00	316.00	362.00
CODE	70201	70302	70403	70604	70805	78806	71207	71608	71809
Outer/Master	10/120	10/120	10/120	5/80	5/80	5/60	5/45	5/40	5/40
SIZE (WxHxL) mm	75x73x51	100x73x51	135x73x51	208x73x51	230x73x51	135x130x60	209x130x60	230x144x60	209x200x60

METAL GANG BOXES



FLUSH MOUNTING PLASTIC GANG BOXES (FIRE RESISTANT)

GANG BOX →	1 & 2M	3M	4M	6M	8M(H)	8M(V)	12M	16M	18M
MRP ₹ ↓	76.00	87.00	104.00	137.00	164.00	164.00	217.00	255.00	310.00
CODE	80201	80302	80403	80604	80805	88806	81207	81608	81809
Outer/Master	10/120	10/120	10/120	5/80	5/80	5/60	5/45	5/40	5/40
SIZE (WxHxL) mm	79x82x50	104x82x50	139x82x50	213x82x50	263x86x55	141x142x55	213x143x55	249x150x55	214x211x58

PLASTIC GANG BOXES

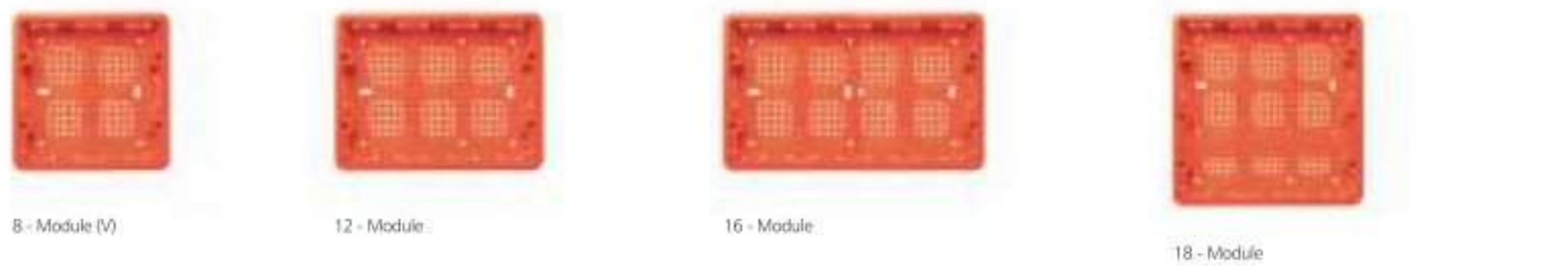

SURFACE MOUNTING PLASTIC GANG BOXES (FIRE RESISTANT)

GANG BOX →	1 & 2M	3M	3M	4M	6M	8M(H)	8M(V)	12M	16M	18M
MRP ₹ ↓	75.00	109.00	109.00	117.00	147.00	187.00	187.00	237.00	265.00	315.00
CODE	90201	90302	93303	90404	90605	90806	98807	91208	91609	91810
Outer/Master	10/120	10/120	10/120	10/120	5/80	5/80	5/60	5/45	5/40	5/40
SIZE (WxHxL) mm	92x85x48	124x85x48	118x85x48	150x85x48	218x85x48	267x85x48	153x154x48	219x154x48	267x154x48	224x227x48

PLASTIC SURFACE GANG BOXES

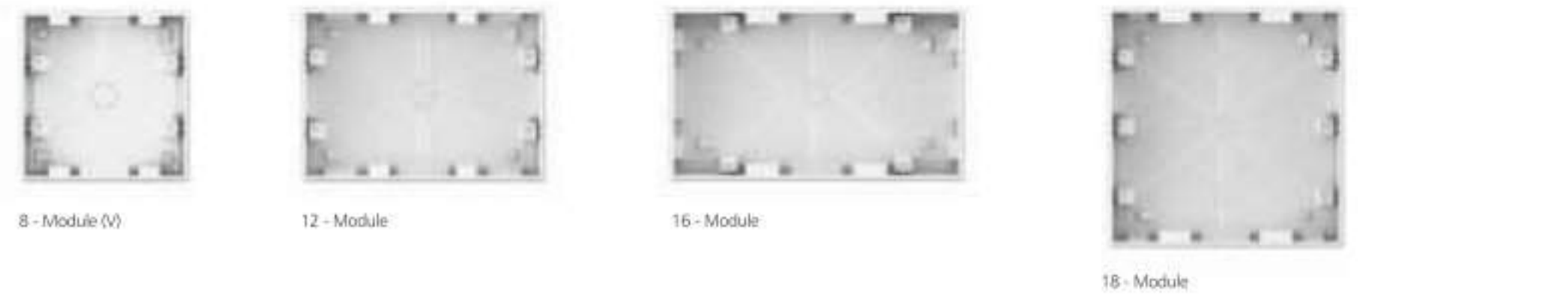
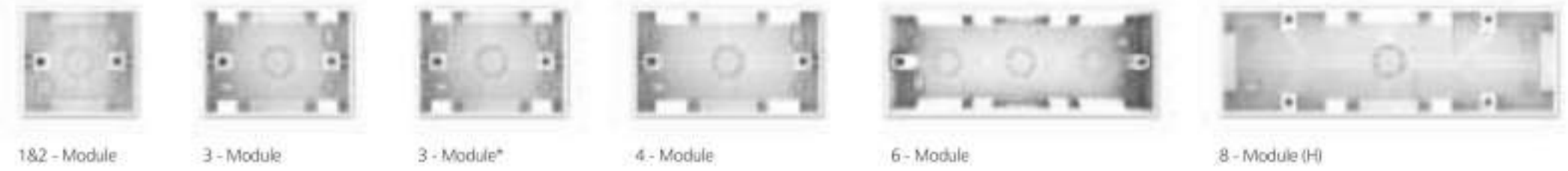

G- SURFACE MOUNTING PLASTIC GANG BOXES (FIRE RESISTANT) Suitable for Grazia & Glassio

GANG BOX →	1 & 2M	3M	4M	4M (HV)	6M	8M(H)	8M(HV)	8M (V)	9M	12M	16M	18M
MRP ₹ ↓	82.00	124.00	137.00	137.00	172.00	225.00	225.00	225.00	254.00	277.00	321.00	374.00
CODE	100201	100302	100403	100404	100605	100806	100807	108808	100909	101212	101611	101812
Outer/Master	10/120	10/120	10/120	10/120	5/80	5/80	5/80	5/60	5/80	5/45	5/40	5/40
SIZE (WxHxL) mm	91x89x48	119x89x48	145x89x48	150x89x48	218x89x48	243x89x48	263x89x48	154x155x48	279x89x48	218x155x48	243x155x48	218x222x48

PLASTIC SURFACE GANG BOXES

Note: Not suitable for Grazia 8M (V) Plate



More reasons to
welcome with a smile!



HERE
THEY ALL COME
TOGETHER

BUZY  BEE

ADD
ANOTHER
DIMENSION TO YOUR
FOUR WALLS.

GHEXO



MAKE
WARM WELCOMES
WARMER!

POLYGON

THE
SEA HAS
MANY SECRETS.
REVEAL ONE ON
YOUR WALL.

GSHOELL



Say goodbye to dull,
boring doorbells.



THE ULTIMATE
STAR OF
YOUR DECOR.
STAR SPACE

ANNOUNCE
YOUR
GUESTS IN STYLE!
GALAXY



STYLISH HOMES
DESERVE STYLISH
WELCOMES.
ALPHA

DISTINCTIVE
LOOKS.
REMARKABLE
SOUND.
SOUND⁹



More reasons to
welcome with a smile!



ZOOMBA AND
ZOOMBA PLUGIN BELL

REMOTE



ZOOMBA
PLUGIN BELL
THE CIRCULAR
SYMPHONY.

GROOVE WITH
EVERY BUZZ!

ZOOMBA



EXQUISITE
SOUND
ON EVERY RING.

EXO



GET, SET,
PLUG AND RING!

ULTRA

ULTRA AND
EXO PLUGIN BELL

REMOTE





Code	Item	MRP ₹	Pkg.
DING DONG DOOR BELL			
203048	Ocean Stereophonic Ding Dong	218.00	5/100
203049	Aqua Stereophonic Ding Dong	218.00	5/100
203050	Snowwhite Stereophonic Ding Dong	216.00	5/100
203051	Belaton Stereophonic Ding Dong	218.00	5/100
203052	Woofers Stereophonic Ding Dong	266.00	5/100
203053	G-Spot Stereophonic Ding Dong	262.00	5/100
203054	Prism Stereophonic Ding Dong	216.00	5/100
GL422	Angel Ding Dong Bell	217.00	5/150

Code	Item	MRP ₹	Pkg.
ELECTRONIC DOOR BELL			
204061*	G-Shell Polyphonic With Selectable Tunes & Flashing Light, 2 Mode Selection, Ding Dong Melody & English Multitune - 17 Melodies	420.00	5/60
204062	G-Space Polyphonic 4 Mode Selection, Big Ben Chime & Pod, Amitabh Song Tunes & Pod - 18 Melodies Big Ben Chime, Amitabh Song Tunes - 18 Melodies	505.00	5/60
204063	G-Hexo 4 Mode Selection, Hindi Multitune - 8 Melodies, English Multitune - 8 Melodies, Ding Dong Melody, Big Ben Chime	464.00	5/60
204064	G-Oxi Polyphonic with selectable tunes & flashing light 4 mode selection, Big Ben chime, Hindi multitune, & POD - 20 melodies, Hindi multitune & POD - 26 melodies, Hindi multitune - 20 melodies	529.00	5/60
204065	Buzy-Bee Polyphonic 4 Mode Selection, Big Ben Chime & Pod, Amitabh Song Tunes & Pod - 18 Melodies Big Ben Chime, Amitabh Song Tunes - 18 Melodies	600.00	5/60
204066*	G-Astro Polyphonic With Selectable Tunes & Flashing Light, 4 Mode Selection, Hindi Multitune - 8 Melodies, English Multitune - 8 Melodies, Ding Dong Melody, Big Ben Chime	479.00	5/60
204067*	Polygon Single Tune - Ding Dong melody	375.00	5/60
204070	Welcome Piano Tunes With Flashing Light Hindi Multitune & Pod - 24 Melodies	491.00	5/60
204072	Pulse Piano Tunes With Flashing Light English Multitune & Pod - 18 Melodies	491.00	5/60
204078	Zyro (Mp3 Door Bell) In-built 128 Mb Storage, Pre-recorded Tunes And Melodies, Volume Control & Shuffle Function Customize & Store Your Own Music. (Supplied With Usb Cable For File Transfer)	1299.00	5/60
204082	Red Dot Polyphonic With Selectable Tunes & Flashing Light Volume Control & Shuffle Function 4 Mode Selection, Hindi Multitune - 20 Melodies, Hindi Multitune & Pod - 20 Melodies Fur Elis E Piano Tune, Big Ben Chime	600.00	5/60
204083	Salsa Polyphonic With Selectable Tunes & Flashing Light 4 Mode Selection, Hindi Multitune-20 Melodies, & Pod, Big Ben Chime, Hindi Multitune With Pod - 26 Melodies, Hindi Multitune-20 Melodies	567.00	5/60

* introducing shortly

Code	Item	MRP ₹	Pkg.
MANTRA DOOR BELL			
204079	Ek Mantra - Gayatri Mantra	383.00	5/90
204080 A	Ekaant - Mantra Bell with 4 selectable mantras & flashing light 14 mode selection - Jain Stuti, Gurubani, Maha Laxmi & Tirupati Balaji Mantra)	479.00	5/60
204080 B	Ekaant - Mantra Bell with 4 selectable mantras & flashing light 14 mode selection - Guru Mantra, Maha Mritunjaya, Ganeshji & Sainath Mantra)	479.00	5/60
204080 C	Ekaant - Mantra Bell with 4 selectable mantras & flashing light 14 mode selection - Sri Krishna, Ding Dong, Azaan & Gayatri Mantra)	479.00	5/60
204080 D	Ekaant Polyphonic With 4 Selectable Tune & Flashing Light	479.00	5/60

Code	Item	MRP ₹	Pkg.
ELECTRONIC DOOR BELL			
204501*	Sound 9 Push & Select Function with Flashing LED Light, English Multitune - 16 Melodies, Polyphonic Tunes	-	5/60
204501A*	Sound 9 with Remote Push & Select Function With Flashing LED Light, English Multitune - 16 Melodies, Polyphonic Tunes	-	5/60
204502*	Alpha Push-Select Function With Flashing Light, Ding Dong Melodies, Big Ben Chime & English Piano Tune, 3 Polyphonic Tunes	460.00	5/60
204503*	Galaxy Slide & Select Function With Flashing Light, Ding Dong Melodies, Big Ben Chime & English Piano Tune, 3 Polyphonic Tunes	480.00	5/60
204504*	Edge Polyphonic Polyphonic With Selectable Tunes & Flashing Light 2 Mode Selection Hindi Multitunes & Pod - 28 Melodies, Big Ben Chime	429.00	5/60
204507*	Star Space Piano tune - English single tune	490.00	5/60

Code	Item	MRP ₹	Pkg.
ELECTRONIC BIRD CHIME BELL			
GL461	Cuckoo Bird Chime	339.00	5/60
GL462	Parrot Bird Chime	347.00	5/100
GL464	Buzzer	77.00	10/300
GL465	Mini Parrot Bird Chime	296.00	10/120

Code	Item	MRP ₹	Pkg.
WIRELESS PLUG-IN DOOR BELL			
204505	Exo Plug-In Wireless Bell with Remote, 32 Selectable Melodies, Play-Pause, Forward-Revered Volume Control Function Direct AC Power (No Battery Required for Bell, Battery Required Only for Remote)	-	5/60
204506	Ultra Plug-In Wireless Bell with Remote, Single Ding-Dong Melody, Play-Pause Function Direct AC Power (No Battery Required for Bell, Battery Required Only for Remote)	-	5/60

Code	Item	MRP ₹	Pkg.
ALARM BELLS			
207202	Liquid Water Alarm Bell Single Tune Water Alarm Sound With Flashing Led Light	680.00	1/60



Power, Freedom
and Style.



i-Strip LED Spike Guard with Surge Protector

Curvē plus

Enjoy real convenience and real freedom by connecting your electrical appliances to where you are – whether it's for work, entertainment or household chores. Available in various design options with the flexibility to connect national and international plugs, these spike guards and power strips ensure you always stay connected and on. So go ahead, unwind and connect everything you need.

Logica Spike Guard with Surge Protector



G-Xpress Spike Guard with Surge Protector

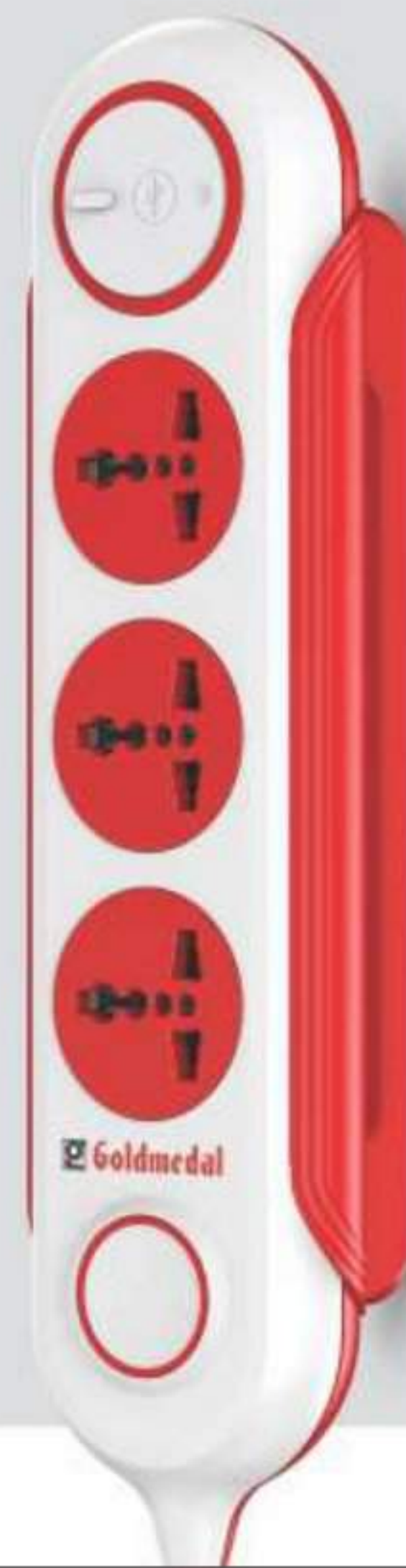



205101



205102



205103



205107



205100



205104



205106



205215



GL655



GL656



205108

Code	Item	MRP ₹	Pkg.
------	------	-------	------

HIGH GRADE ADAPTORS 240V-

205101	i-Strip LED Spike Guard 6 Outlet International Socket, Master Switch, Indicator With Surge Protector - 2 Mtr Cables	1162.00	5/30
--------	--	---------	------

POWER STRIP 240V-

205102	i-Design 4x1 Power Strip 4 Outlet International Socket With Master Switch & Indicator - 2 Mtr Cables	709.00	5/30
205103	i-Design 4x4 Power Strip 4 Outlet International Socket With Individual Switch & Indicator - 2 Mtr Cables	1018.00	5/30
205107	i-Design 4x4 Power Strip with USB 3 Outlet International Socket, Dual USB Port - Output 2100mA, With Individual Switch & Indicator - 2 Mtr Cables	1399.00	5/30

360° HIGH GRADE ADAPTORS 240V-

205100	360° Power Strip 6 Outlet International Socket, Master Switch With Indicator - 2 Mtr Cables	828.00	5/30
205104	360° Spike Guard 5 Outlet International Socket, Master Switch With Indicator & Reset Switch With Surge Protector - 2 Mtr Cables	828.00	5/30
205106	360° Spike Guard with USB 4 Outlet International Socket, Dual USB Port - Output 2100mA., Master Switch With Indicator & Reset Switch - 2 Mtr Cables	1100.00	5/30

POWER STRIP / SPIKE GUARD 240V-

205215	Zippo Power Strip with USB 3 Outlet International Socket, Master Switch, Indicator & 3 USB Ports - Output 2.1A Max - 1.5 Mtr Cables	980.00	5/30
GL655	4 Outlet Power Strip [with international socket outlet]	575.00	5/60
GL656	6 Outlet Spike Adapter with Switch & Lamp [surge & spike protection with international socket outlet]	875.00	5/40

HIGH GRADE ADAPTORS SPIKE GUARD 240V-

205108	G-Trix 4x1 Spike Guard 4 Outlet International Socket, Master Switch With Indicator & Reset Switch With Surge Protector - 2 Mtr Cables	644.00	5/30
--------	---	--------	------

Code	Item	MRP ₹	Pkg.
------	------	-------	------

HIGH GRADE ADAPTORS SPIKE GUARD 240V-

205211	G-Xpress 4x1 Spike Guard 4 Outlet International Socket With Master Switch With Indicator - 2 Mtr Cables	790.00	5/30
205212	G-Xpress 4x1 Spike Guard with USB 3 Outlet International Socket, Dual USB Port - Output 2100mA., Master Switch With Indicator - 2 Mtr Cables	1499.00	5/30
205213	Logica 4x1 Spike Guard 4 Outlet International Sockets, Master Switch With Indicator & Reset Switch With Surge Protector - 2 Mtr Cables	690.00	5/30
205216	Taco 3x1 Spike Guard NEW 3 Outlet International Sockets & Master Switch With Indicator & Reset Switch With Surge Protector - 2 Mtr Cables	590.00	5/30
205217	Spice Mini 4x1 NEW 4 Outlet International Sockets, Master Switch With Indicator & Reset Switch With Surge Protector - 2 Mtr Cables	620.00	5/30
205218	Spice Max 6x1 NEW 6 Outlet International Sockets, Master Switch With Indicator & Reset Switch With Surge Protector - 2 Mtr Cables	800.00	5/30



ESSENZA POWER STRIP 240V-

09207	Plugged-IN 4x4 Power Strip with USB 3 Outlet International Sockets & Dual USB Charger, Individual Switch With Indicator - 2 Mtr Cables	1299.00	5/30
09208	Plugged-IN 4x1 Power Strip 4 Outlet International Sockets, Master Switch With Indicator - 2 Mtr Cables	699.00	5/30
09209	Plugged-IN 4x4 Power Strip 4 Outlet International Sockets, Individual Switch With Indicator - 2 Mtr Cables	995.00	5/30
09210	Plugged-IN 4x1 Power Strip 4 Outlet International Sockets, Master Switch With Indicator - 5 Mtr Cables	918.00	5/30



ESSENZA SPIKE GUARD 240V-

09211	Plugged-IN 6x1 Spike Guard 6 Outlet International Sockets, Master Switch With Indicator & Reset Switch With Surge Protector - 2 Mtr Cables	1057.00	5/30
-------	--	---------	------



205211



205212



205213



205216



205217



205218



09207



09208



09209



09211

Connecting devices. Safeguarding lives.

International Socket
with safety shutter

Power Indicator

High Grade Brass parts



Heavy Duty
Power Cord

Ultra Smooth
Rotation



Infino Extension Cord
with International Socket and
safety shutter



Krysta Extension Cord
with International Socket and
safety shutter

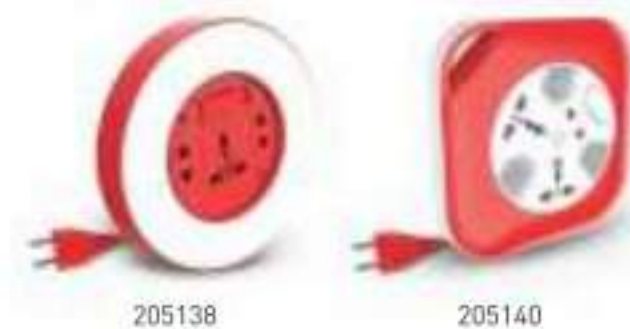

Code	Item	MRP ₹	Pkg.
			Outer/Master
2 PIN EXTENSION CORD WITH HANDLE			
205116	Sliq 2 Pin With Handle - Master Switch With Indicator, International Socket & 2 Pin Sockets - 5 Mtr Cables	455.00	5/60
205118	Quord 2 Pin With Handle - Master Switch With Indicator, International Socket & 2 Pin Sockets - 5 Mtr Cables	456.00	5/60
205126	G-Expert 2 Pin With Handle - Master Switch With Indicator, International Socket & 2 Pin Sockets - 5 Mtr Cables	456.00	5/60
3 PIN EXTENSION CORD WITH HANDLE			
205117	Sliq 3 Pin With Handle - Master Switch With Indicator, International Socket & 2 Pin Sockets - 4 Mtr Cables	564.00	5/60
205119	Quord 3 Pin With Handle - Master Switch With Indicator, International Socket & 2 Pin Sockets - 4 Mtr Cables	586.00	5/60
205127	G-Expert 3 Pin With Handle - Master Switch With Indicator, International Socket & 2 Pin Sockets - 4 Mtr Cables	658.00	5/60
2 PIN EXTENSION CORD WITHOUT HANDLE			
205120	Dazzle 2 Pin Master Switch With Indicator, International Socket & 2 Pin Sockets - 5 Mtr Cables	424.00	5/60
205122	Twister 2 Pin Master Switch With Indicator, International Socket & 2 Pin Sockets - 5 Mtr Cables	421.00	5/60
205124	G-Smart 2 Pin Master Switch With Indicator, International Socket & 2 Pin Sockets - 5 Mtr Cables	440.00	5/60
205128	G-Dial 2 Pin 5 Mtr Cable Master Switch With Indicator, International Socket & 2 Pin Sockets - 5 Mtr Cables	424.00	5/60
205133	Gio 2 Pin With Indicator & International Sockets - 2.5 Mtr Cables	362.00	5/60
205135	Krysta 2 Pin Master Switch With Indicator, International Sockets & 2 Pin Socket - 5 Mtr Cables	524.00	5/60
205138	Plano 2 Pin Master Switch With Indicator, International Socket & 2 Pin Sockets - 5 Mtr Cables	486.00	5/60
205140	Infino 2 Pin Master Switch With Indicator, International Sockets & 2 Pin Socket - 5 Mtr Cables	571.00	5/60

Code	Item	MRP ₹	Pkg.
			Outer/Master
3 PIN EXTENSION CORD WITHOUT HANDLE			
205121	Dazzle 3 Pin Master Switch With Indicator, International Socket & 2 Pin Sockets - 4 Mtr Cables	528.00	5/60
205123	Twister 3 Pin Master Switch With Indicator, International Socket & 2 Pin Sockets - 4 Mtr Cables	545.00	5/60
205125	G-Smart 3 Pin Master Switch With Indicator, International Socket & 2 Pin Sockets - 4 Mtr Cables	580.00	5/60
205134	Gio 3 Pin Master Switch With Indicator, International Socket & 2 Pin Sockets - 1.5 Mtr Cables	430.00	5/60
205139	Plano 3 Pin Master Switch With Indicator, International Socket & 2 Pin Sockets - 4 Mtr Cables	626.00	5/60
HIGH GRADE 16A EXTENSION CORD			
205131	Twister 16A 3 Pin Master Switch With Indicator, 6/16A Uni. Socket, International Socket & 2 Pin Socket - 3.5 Mtr Cables	1008.00	5/30
205132	G-Expert 16A 3 Pin With Handle - Master Switch With Indicator, 6/16A Uni. Socket, International Socket & 2 Pin Socket & Tripper - 3.5 Mtr Cables	1074.00	5/30
DECORATIVE WIRE LINK			
205149	Decorative Wire Link With 2 Pin Plug & Pendant Holder - 5 Mtr Cables	227.00	5/60
ESSENZA EXTENSION CORDS 240V~			
09201	Flexi 2 Pin Master Switch With Indicator, International Socket & 2 Pin Sockets - 5 Mtr Cables	421.00	5/60
09202	Flexi 2 Pin Master Switch With Indicator, International Socket & 2 Pin Sockets - 7.5 Mtr Cables	533.00	5/60
09203	Flexi 3 Pin Master Switch With Indicator, International Socket & 2 Pin Sockets - 4 Mtr Cables	533.00	5/60
UREA EXTENSION CORDS 240V~			
GL403	Round 2 Pin - 4 Mtr.	417.00	5/80
GL404	Round 2 Pin - 8 Mtr.	547.00	5/80





206151

206152

Code Item MRP ₹ Pkg.

Outer/Master

LED NIGHT LAMPS

206151 Hot Shot Night Lamp with LED 103.00 10/300

206152 Desire Night Lamp with LED 94.00 10/300

Available colour: Blue, Yellow & Orange

EDGE GLOW LED / NIGHT LAMPS

206161 Divine Glow - Shri Parashwanath Edge Glow LED Night Lamp 150.00 10/300

206162 Divine Glow - Lord Ganesha Edge Glow LED Night Lamp 150.00 10/300

206163 Divine Glow - Maha Laxmi Edge Glow LED Night Lamp 150.00 10/300

206164 Divine Glow - Tirupati Balaji Edge Glow LED Night Lamp 150.00 10/300

206165 Divine Glow - Guru Nanak Edge Glow LED Night Lamp 150.00 10/300

206166 Divine Glow - Azaan Edge Glow LED Night Lamp 150.00 10/300

206169 G-Focus Night Lamp With LED 235.00 10/300

206170 A G-Divine Shri Parashwanath Edge Glow LED Night Lamp 180.00 5/100

206170 B G-Divine Lord Ganesha Edge Glow LED Night Lamp 180.00 5/100

206170 C G-Divine Maha Laxmi Edge Glow LED Night Lamp 180.00 5/100

206170 D G-Divine Tirupati Balaji Edge Glow LED Night Lamp 180.00 5/100

206170 E G-Divine Guru Nanak Edge Glow LED Night Lamp 180.00 5/100

206170 F G-Divine Azaan Edge Glow LED Night Lamp 180.00 5/100

SELF ADHESIVE PVC ELECTRICAL INSULATION TAPE

06326 PVC Electrical Insulation Tape (6mtr) 17.00 30/600
Size: 0.125mm x 17mm x 6mtr.

06330 PVC Electrical Insulation Tape (15mtr) 45.00 16/256
Size: 0.125mm x 17mm x 15mtr. **NEW**

06331 PVC Electrical Insulation Tape (25mtr) 55.00 10/240
Size: 0.125mm x 17mm x 25mtr. **NEW**



206161

206162

206163



203164

203165

206169



206170 A

206170 B

206170 C



206170 D

206170 E

206170 F



06326

06330

06331

The power to shape your world.



Powergrip Plug Top
LDS System, Easy & Safe Grip



Spice 3 Pin Universal
Travel Adaptor
With Indicator



Groove Plug Top
LDS System, Easy & Safe Grip



Beetle Plug Top
LDS System, Easy & Safe Grip



202026/202027



202028/202029



202030/202031



202071



202072



202073



202074



202075



202076



GL213



GL214



GL213



GL214



202037



202039



202042



202043/45



202044/46

Code	Item	MRP ₹	Pkg.
			Outer/Master
PLUG TOPS 240V~			
202026	Avian 6A 3 Pin Plug LDS System, Easy & Safe Grip	83.00	20/600
202027	Avian 16A 3 Pin Plug LDS System, Easy & Safe Grip	105.00	10/300
202028	Fusion 6A 3 Pin Plug LDS System, Easy & Safe Grip	86.00	20/600
202029	Fusion 16A 3 Pin Plug LDS System, Easy & Safe Grip	108.00	10/300
202030	G-grip 6A 3 Pin Plug with LED LDS System, Easy & Safe Grip	96.00	20/600
202031	G-grip 16A 3 Pin Plug with LED LDS System, Easy & Safe Grip	112.00	10/300
202071	Powergrip 6A 3 Pin Plug NEW LDS System, Easy & Safe Grip	89.00	20/600
202072	Powergrip 16A 3 Pin Plug NEW LDS System, Easy & Safe Grip	114.00	10/300
202073	Groove 6A 3 Pin Plug NEW LDS System, Easy & Safe Grip	88.00	20/600
202074	Groove 16A 3 Pin Plug NEW LDS System, Easy & Safe Grip	113.00	10/300
202075	Beetle 6A 3 Pin Plug with LED NEW LDS System, Easy & Safe Grip	87.00	20/600
202076	Beetle 16A 3 Pin Plug with LED NEW LDS System, Easy & Safe Grip	112.00	10/300

3 PIN PLUG TOP (UREA)			
GL213	Cub 6A 3 Pin Top	70.00	20/600
GL214	Cub 16A 3 Pin Top	105.00	10/300

16A PILOT SWITCH / SOC. / ROUND TOP (UREA)			
GL384	16A Surface 3Pin Socket (Round Black)	124.00	10/160
GL385	16A 3 Pin Top (Round Black)	118.00	20/240

UNIVERSAL TRAVEL ADAPTOR 240V~			
202037	i-Link 16A 3 Pin Universal Travel Adaptor With Mobile Socket	215.00	10/120
202039	Sliq 3 Pin Universal Travel Adaptor LDS System, Easy & Safe Grip With Indicator	91.00	20/300
202042	Spice 3 Pin Universal Travel Adaptor With Indicator	154.00	10/300
202043	G-cube 2 Pin Universal Travel Adaptor With Surge Protector	71.00	20/300
202044	G-dot 2 Pin Universal Travel Adaptor With Surge Protector	71.00	20/300
202045	G-cube 2 Pin Universal Travel Adaptor	61.00	20/300
202046	G-dot 2 Pin Universal Travel Adaptor	61.00	20/300

* Suitable for all kinds of plugs used around the world

Code	Item	MRP ₹	Pkg.
			Outer/Master
UNIVERSAL TRAVEL ADAPTOR WITH USB CHARGER 240V~			
202047	Genius USB Travel Adaptor Dual USB Port With 3 International Plug	973.00	10/120
202050	Zesto Travel Adaptor Dual USB With International Socket	530.00	10/120



ESSENZA LAMP HOLDER / BED SWITCH			
09190	Bed Switch	60.00	20/1200
09191	Skirt Pendant Holder	43.00	30/600

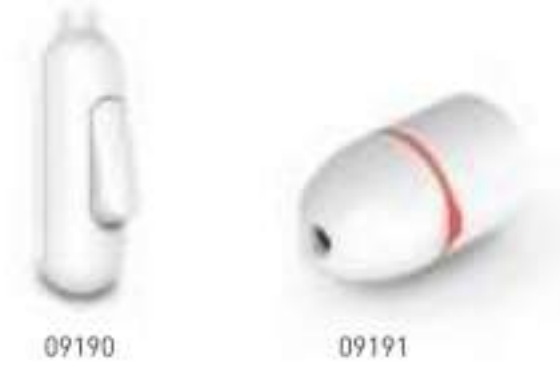

ADAPTOR / SKIRT PENDANT HOLDER (UREA)			
GL195	Adaptor	29.00	30/720
GL206	Skirt Pendant Holder	37.00	30/720



CEILING ROSE 240V~			
201016	Pilot Ceiling Rose Advanced Interlock Configuration	51.00	20/600
201017	Jumbo Ceiling Rose Advanced Interlock Configuration	62.00	20/400
201018	Glassio Ceiling Rose Advanced Interlock Configuration	77.00	20/400



GIFA LAMP HOLDER / CEILING ROSE 240V~			
GF02103	Igloo Angle Holder (Metal) Advanced Interlock Configuration	76.00	20/400
GF02104	Igloo Batten Holder (Metal) Advanced Interlock Configuration	76.00	20/400
GF02116	Pilot Ceiling Rose Advanced Interlock Configuration	51.00	20/600
GF02117	Jumbo Ceiling Rose Advanced Interlock Configuration	62.00	20/400



More ways to power
your dreams!



Code	Item	MRP ₹	Pkg.
LAMP HOLDER 240V~			
201001	Oro Angle Holder Advanced Interlock Configuration	75.00	20/400
201002	Oro Batten Holder Advanced Interlock Configuration	75.00	20/400
201003	Ecco Angle Holder Advanced Interlock Configuration	77.00	20/400
201004	Ecco Batten Holder Advanced Interlock Configuration	77.00	20/400
201005	Angle Holder Advanced Interlock Configuration	63.00	20/400
201006	Batten Holder Advanced Interlock Configuration	63.00	20/400
201007	Jumbo Batten Holder Advanced Interlock Configuration	75.00	20/400
201008	Ecco Gama Batten Holder Advanced Interlock Configuration	90.00	20/400
201010	Gzifa Angle Holder Advanced Interlock Configuration	81.00	20/400
201011	Gzifa Batten Holder Advanced Interlock Configuration	81.00	20/400
201012	Oval Angle Holder Advanced Interlock Configuration	106.00	10/300
201013	Oval Batten Holder Advanced Interlock Configuration	106.00	10/300
201009	Glassio Angle Holder Advanced Interlock Configuration	99.00	10/300
201014	Glassio Batten Holder Advanced Interlock Configuration	99.00	10/300
201019	Euro Angle Holder Advanced Interlock Configuration	114.00	10/300
201020	Euro Batten Holder Advanced Interlock Configuration	114.00	10/300
201021	Zen Angle Holder 5x5 Advanced Interlock Configuration	NEW 112.00	10/300
201022	Zen Batten Holder 5x5 Advanced Interlock Configuration	NEW 112.00	10/300
207253	Ola Angle Holder Advanced Interlock Configuration	NEW 75.00	20/400
207254	Ola Batten Holder Advanced Interlock Configuration	NEW 75.00	20/400
207257	Uber Angle Holder Advanced Interlock Configuration	NEW 74.00	20/400
207258	Uber Batten Holder Advanced Interlock Configuration	NEW 74.00	20/400



High performance
delivered. Safely.

THE ULTIMATE
STAR OF
YOUR DECOR.

NANO ADAPTOR



THE ELEGANT
WAY TO STAY
CHARGED!

I-POWER



NEVER GO OUT
OF CHARGE.

WALL-E ADAPTOR



THE
COOLEST WAY TO
STAY CHARGED.

I-RAPID





Code	Item	MRP ₹	Pkg.
HIGH GRADE POWER STRIP 240V~ NEW			
209051	Caterpillar 3+1 Power Strip 3 Outlet International Sockets With Safety Shutter, Master Switch With Indicator - 1.8 Mtr Cables	1000.00	-/30
209052	Caterpillar 3+1 Power Strip With USB Dual USB Port, 2 Outlet International Sockets With Safety Shutter, Master Switch With Indicator - 1.8 Mtr Cables	1200.00	-/30
HIGH GRADE POWER STRIP 240V~ NEW			
209053	Turbomax 8+4 Power Strip 8 Outlet International Sockets With Safety Shutter, 3 USB + 1 USB C Type Ports, Master Switch With Indicator - 2 Mtr Cables	2750.00	-/30
209054	Turbocharge 4+3 Power Strip 4 Outlet International Sockets With Safety Shutter, Dual USB + 1 USB C Type Ports, Master Switch With Indicator - 2 Mtr Cables	1900.00	-/30
UNIVERSAL TRAVEL ADAPTOR 240V~ NEW			
202048	Auro Travel Charger Input: 100-240V-50/60Hz 0.8A 36W Total Output Auto ID (118W Max) Output: 5V 3A 9V 2A 12V 1.5A USB+Type-C Output: 5V 3A - 2 Mtr Cables Quick Charge 3.0+PD	2499.00	01/30
209001	I-Charge - 17W CHARGER + NIGHT LAMP Dual USB Port With 3 International Plug Auto ID (118W Max) Output: 5V 3A 9V 2A 12V 1.5A USB+Type-C Output: 5V 3A Total Power: 18W (Max) Quick Charge 3.0+PD	950.00	05/50
209002	I-Rapid - 25W CHARGER + NIGHT LAMP 1 USB A + 1 USB C Type Ports, PD Output: 5V 3A, 9V 2.78A, 12V 2.08A(25W) QC Output: 5V 3A, 9V 2A, A12V 1.5A (18W) Total Power: 25W (Max) Quick Charge 3.0+PD	1110.00	05/50
209003	I-Power - 30W CHARGER WITH DIGITAL DISPLAY 1 USB A + 1 USB C Type Ports, PD Output: 5V 3A, 9V 3A, 12V 2.5A, 15V 2A, 20V 1.5A (30W) PPS: 3.3-12V 2.5A, 3.3-20V 1.5A QC Output: 5V 4.5A, 9V 2A, 12V 2.5A (30W) Total Power: 30W (Max) Quick Charge 3.0+PD	1210.00	05/50
209004	16A Smart Wi-fi Power Socket For Air Conditioner & Geyser, Compatible With Amazon Alexa, Google Home	1850.00	05/-
209005	Nano Travel Adapter With Mobile Stand, International Socket, 2 Pin Socket & Indicator	300.00	-
209006	Wall-E Travel Adapter With Mobile Stand, 2 International Sockets, 2 Pin Sockets, Master Switch With Indicator	600.00	-

Please refer discount policy for Curve Plus Pro



CATERPILLAR
with International Socket,

CATERPILLAR
International Socket
with USB Charger

TURBO CHARGE
International Socket,
USB Charger
A Type & C Type

gazelle
WOOD PLATES

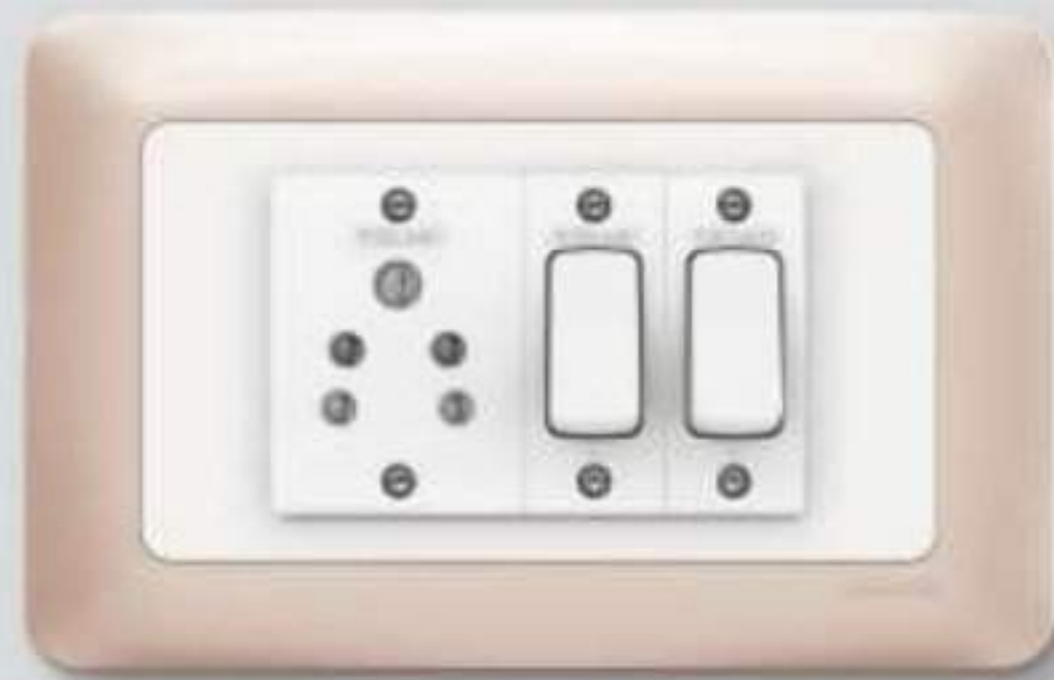

Gazelle Wood panels provide all the flexibility you need to install switches and other electrical modules. Its snap - fix frame is easy to use and available in three colors to match your interiors. Designed for durability, the Gazelle Wood panels deliver outstanding performance and reliability.



GAZELLE WOOD PLATE - SUITABLE FOR WOODEN BOXES

Gazelle Wood Plate	4.5 x 4.5	5 x 5	4.5 x 6.5	5 x 7	4.5 x 7.5	4.5 x 8.5	4.5 x 10.5	4.5 x 12.5
COLOURS ↓	MRP Rs. (₹)	MRP Rs. (₹)	MRP Rs. (₹)	MRP Rs. (₹)	MRP Rs. (₹)	MRP Rs. (₹)	MRP Rs. (₹)	MRP Rs. (₹)
PLATINA	52.00	58.00	70.00	83.00	83.00	95.00	131.00	143.00
METALIQ	73.00	80.00	100.00	116.00	116.00	132.00	158.00	185.00
CODE →	14229	14236	14230	14240	14235	14231	14232	14233
Outer / Master →	10/360	10/360	10/360	10/180	10/180	10/180	10/120	10/120

Gazelle Wood Plate	4.5 x 15.5	6.5 x 8.5	6.5 x 10.5	6.5 x 12.5	7.5 x 10.5	8.5 x 10.5	8.5 x 12.5	10.5 x 12.5
COLOURS ↓	MRP Rs. (₹)	MRP Rs. (₹)	MRP Rs. (₹)	MRP Rs. (₹)	MRP Rs. (₹)	MRP Rs. (₹)	MRP Rs. (₹)	MRP Rs. (₹)
PLATINA	166.00	166.00	190.00	212.00	232.00	246.00	253.00	263.00
METALIQ	232.00	232.00	245.00	251.00	264.00	284.00	304.00	370.00
CODE →	14234	14237	14238	14239	14242	14244	14245	14248
Outer / Master →	10/120	10/180	10/120	10/120	10/120	10/120	10/120	10/80

Gazelle Wood Plate



AVAILABLE COLOURS IN PLATES
Platina : White Jazz & Ivory
MetaliQ : Digital Silver



Code	Item	MRP ₹	
		White Brown Sugar	Pkg. Outer/ Master
ESSENZA 10AX VANILLA SWITCHES			
09101	1 Way Switch	28.00	20/1200
09102	2 Way Switch	40.00	20/1200
09103	Bell Push	40.00	20/1200
09104	Indicator	43.00	20/1200

ESSENZA 10AX iCUBE SWITCHES			
09105	1 Way Switch	27.00	20/1200
09106	2 Way Switch	37.00	20/1200
09107	Bell Push	37.00	20/1200
09108	Indicator	42.00	20/1200

ESSENZA 10AX VALLEY SWITCHES			
09109	1 Way Switch	27.00	20/1200
09110	2 Way Switch	37.00	20/1200
09111	Bell Push	37.00	20/1200
09112	Indicator	42.00	20/1200

ESSENZA 6A / 10A SOCKETS			
09128	6A 3 Pin Socket	48.00	10/600

ESSENZA TV SOCKETS			
09130	Mini TV Socket	50.00	20/1200
09131	Medium TV Socket	51.00	20/800

ESSENZA DIMMER / REGULATOR			
09134	Mini Dimmer	261.00	10/600
09135	Medium Dimmer	279.00	10/300
09136	4 Step Regulator	336.00	10/600
09137	5 Step Regulator	375.00	10/300
- Regulator Supplied in ISI & Non ISI			

Code	Item	MRP ₹	
		White Brown Sugar	Pkg. Outer/ Master
ESSENZA G-STAR DIMMER / REGULATOR			
09138	G-star Medium Dimmer	277.00	10/300
09139	G-star 4 Step Regulator	340.00	10/600
09140	G-star 5 Step Regulator	375.00	10/300
- Regulator Supplied in ISI & Non ISI			

ESSENZA TEL. JACK / KIT-KAT FUSE			
09143	Mini Tel Jack	84.00	20/1200
09144	Medium 4 Line Tel Jack	84.00	20/800
09147	Kit-Kat Fuse (Suitable for both 10A & 16A)	67.00	20/800

ESSENZA 6A / 10A S. S. COMBINED			
09236	6A 3 Pin S.S. Combined with Indicator	95.00	5/100
09237	6A 3 Pin S.S. Combined with Indicator (with junction box)	127.00	10/200
09238	6A 3 Pin 8x1 S.S. Combined with Indicator (with junction box)	270.00	10/200

ESSENZA NANO 20A SWITCH (PORCELAIN BASE)			
09154	Nano 20A 1 Way Switch	129.00	10/200
09155	Nano 20A 2 Way Switch with Porcelain Base	149.00	10/200

ESSENZA 20A SWITCH / 16A SOCKET (PORCELAIN BASE)			
09156	20A 1 Way Switch	140.00	10/200
09157	20A 2 Way Switch	161.00	10/200
09158	20A Gama Switch with Indicator	160.00	10/200
09159	20A Gama 2 Way Switch	183.00	10/200
09160	Gama 10A Bellpush with Indicator	118.00	10/200
09161	6 & 16A Universal Socket with safety shutter & Porcelain Base	142.00	10/200

ESSENZA SURFACE GANG BOXES / 32A DP SWITCH			
09164	16A Surface Box (Suitable for Switch/Socket/DP/Gama Switch)	41.00	10/200
09174	32A DP Switch with Indicator with Porcelain Base	248.00	10/200





Code	Item	MRP ₹	Pkg.
		White Brown Sugar	Duster/ Master
ESSENZA 3 IN 1 COMBINED (PORCELAIN BASE)			
09178	3 In 1 S.S. Combined with safety shutter	224.00	5/150
09179	3 In 1 S.S. Combined with Junction Box (with safety shutter)	281.00	5/150
ESSENZA 5 IN 1 COMBINED (PORCELAIN BASE)			
09183	5 In 1 S.S. Combined with Fuse & Indicator with safety shutter	276.00	5/80
09184	5 In 1 S.S. Combined with Fuse, Indicator & Junction Box with safety shutter	341.00	5/80
ESSENZA NANO 20A SWITCH			
09154A	Nano 20A 1 Way Switch	133.00	10/200
09155A	Nano 20A 2 Way Switch	153.00	10/200
ESSENZA 20A SWITCH / 16A SOCKET			
09156A	20A 1 Way Switch	133.00	10/200
09157A	20A 2 Way Switch	153.00	10/200
09158A	20A Gama Switch with Indicator	155.00	10/200
09159A	20A Gama 2 Way Switch	177.00	10/200
09160A	Gama 10A Bellpush with Indicator	114.00	10/200
09161A	6 & 16A Universal Socket with safety shutter	139.00	10/200
ESSENZA SURFACE GANG BOXES / 32A DP SWITCH			
09164A	16A Surface Box (Suitable for Switch/Socket/DP/Gama Switch)	42.00	10/200
09174A	32A DP Switch with Indicator	243.00	10/200
ESSENZA 3 IN 1 COMBINED			
09178A	3 In 1 S.S. Combined with safety shutter	224.00	5/150
09179A	3 In 1 S.S. Combined with Junction Box (with safety shutter)	279.00	5/150
ESSENZA 5 IN 1 COMBINED			
09183A	5 In 1 S.S. Combined with Fuse & indicator (with safety shutter)	276.00	5/80
09184A	5 In 1 S.S. Combined with Fuse, Indicator & Junction Box (with safety shutter)	341.00	5/80

Code	Item	MRP ₹	Pkg.
		White Brown Sugar	Duster/ Master
ESSENZA 6 IN 1 COMBINED			
09185	6 In 1 S.S. Combined with Fuse & indicator with safety shutter	298.00	5/90
09186	6 In 1 S.S. Combined with Fuse, Indicator & Junction Box (with safety shutter)	359.00	5/90
ESSENZA LAMP HOLDER / BED SWITCH			
09188	Angle Holder	76.00	20/400
09189	Batten Holder Advanced interlock configuration	76.00	20/400
ESSENZA CEILING ROSE			
09192	Pilot Ceiling Rose (3 parts)	48.00	20/600
09193	Jumbo Ceiling Rose Auto safe lock	58.00	20/400
ESSENZA 32A VANILLA D. P. SWITCH			
09195	Surface D. P. Switch With Indicator (Unbreakable)	260.00	5/100
09196	Flush D. P. Switch With Indicator (Unbreakable)	260.00	5/100
09197	Nano Surface D. P. Switch With Indicator	244.00	5/100
SINGLE POLE MCBS 240/450V- (1 Module) NEW			
09239	C6 SP MCB	280.00	10/200
09240	C10 SP MCB	280.00	10/200
09241	C16 SP MCB	280.00	10/200
09242	C20 SP MCB	280.00	10/200
09243	C25 SP MCB	280.00	10/200
09244	C32 SP MCB	280.00	10/200
240/450V- 50-60Hz 3.0kA Breaking Capacity			
DOUBLE POLE MCBS 240/450V- (2 Module) NEW			
09245	C6 DP MCB	555.00	10/200
09246	C10 DP MCB	555.00	10/200
09247	C16 DP MCB	555.00	10/200
09248	C20 DP MCB	555.00	10/200
09249	C25 DP MCB	555.00	10/200
09250	C32 DP MCB	555.00	10/200
240/450V- 50-60Hz 3.0kA Breaking Capacity			



You love your home.
We love to help.



UREA SWITCHES

Code	Item	MRP ₹	Pkg. Outer/ Master
6A CUB SWITCH / INDICATOR			
GL101	1 Way Switch	26.00	20/1200
GL102	2 Way Switch	36.00	20/1200
GL104	Bell Push	36.00	20/1200
GL105	Indicator	39.00	20/1200
6A CAPSULE SWITCH / INDICATOR			
GL106	1 Way Switch	26.00	20/1200
GL107	2 Way Switch	36.00	20/1200
GL109	Bell Push	36.00	20/1200
GL110	Indicator	39.00	20/1200
6A / 10A SOCKET			
GL121	6A 3 Pin Socket (2M)	54.00	10/600
KIT-KAT FUSE			
GL123	Cub 10A Kit-Kat Fuse	61.00	20/600
GL125	Cub 16A Kit-Kat Fuse	68.00	10/300
CUB ELECTRONIC DIMMER/FAN REGULATOR			
GL144	300W Mini Dimmer	240.00	10/450
GL145	300W Medium Dimmer	256.00	10/300
GL146	4 step Fan Regulator (switch type)	337.00	10/300
GL147	5 Step Fan Regulator (socket type)	366.00	10/300
- Regulator Supplied in ISI & Non ISI			
16A SWITCH / 6 & 16A. SOCKET			
GL150	Cub 1 Way Switch	130.00	10/200
GL151	Cub 2 Way Switch	144.00	10/200
GL152	Capsule 1 Way Switch	129.00	10/200
GL153	Capsule 2 Way Switch	144.00	10/200
GL154	6 & 16A Universal Socket	134.00	10/200





Code	Item	MRP ₹	Pkg. Outer/ Master
3-IN-ONE / WITH J. BOX			
GL155	Cub 3-in-One Universal Switch Socket Combined	207.00	5/100
GL156	Capsule 3-in-One Universal Switch Socket Combined	207.00	5/100
GL157	Cub / Capsule 3 in one with J. Box	253.00	5/100
5-IN-ONE / WITH J. BOX			
GL158	Cub 5-in-one Uni. Switch Socket Combined with Fuse & Indicator	288.00	5/60
GL159	Capsule 5-in-one Uni. Switch Socket Combined with Fuse & Indicator	288.00	5/60
GL160	Cub /Capsule 5 in one with J. Box	352.00	5/60
32 AMP, DELUXE D. P. SWITCH			
GL187	Deluxe Surface D. P. Switch with Indicator (unbreakable)	260.00	5/100
GL188	Deluxe Flush D. P. Switch with Indicator (unbreakable)	260.00	5/100
	<small>suitable for Cub, Capsule, Sumo & Olive series.</small>		
CEILING ROSE / ADAPTOR			
GL191	Pilot Ceiling Rose (2 plate)	42.00	40/600
SUMO 5-IN-ONE / WITH J. BOX			
GL267	5-in-One Universal Switch Socket Combined with Fuse & Indicator	301.00	5/60
GL268	5-in-One with J. Box	368.00	5/60
SUMO SKIRT LAMP HOLDER			
GL269	Angle Holder	47.00	20/400
GL270	Batten Holder	47.00	20/400

Code	Item	MRP ₹	Pkg. Outer/ Master
16A WA-WAH SWITCH / 6 & 16A. SOCKET			
GL302	16A 1 Way Switch	146.00	10/200
GL303	16A 2 Way Switch	161.00	10/200
GL304	6 & 16A Universal Socket	153.00	10/200
WA-WAH 3-IN-ONE/ WITH J. BOX			
GL305	3-in-One Universal Switch Socket Combined	238.00	5/100
GL306	3-in-One with J. Box	292.00	5/100
WA-WAH 5-IN-ONE/ WITH J. BOX			
GL307	5-in-One Universal Switch Socket Combined with Fuse & Indicator	309.00	5/60
GL308	5-in-One with J. Box	382.00	5/60
16A EURO SWITCH / 6 & 16A. SOCKET			
GL352	16A 1 Way Switch	158.00	10/120
GL353	16A 2 Way Switch	173.00	10/120
GL354	6 & 16A Universal Socket	167.00	10/120
3 IN ONE / 5 IN ONE WITH J. BOX			
GL359	Euro 3-in-one with Junction Box	339.00	5/60
GL360	Euro 5-in-one with Junction Box	463.00	5/60
FOOT LIGHT PLATE			
GL479	Moonlite (modular) New LED based multipurpose lighting system	696.00	5/80
AC, MCB JUNCTION BOX			
GL489	Round Junction Plate	14.00	50/2000
GL489A	Round Junction Plate (Dummy)	14.00	50/2000
GL490	Fansheet	43.00	50/400
GL491	Med Round Junction Plate	18.00	50/1000
GL502	MCB Enclosure (1-2 Plate)	70.00	10/200
GL503	MCB Enclosure (3-4 Plate)	103.00	5/100



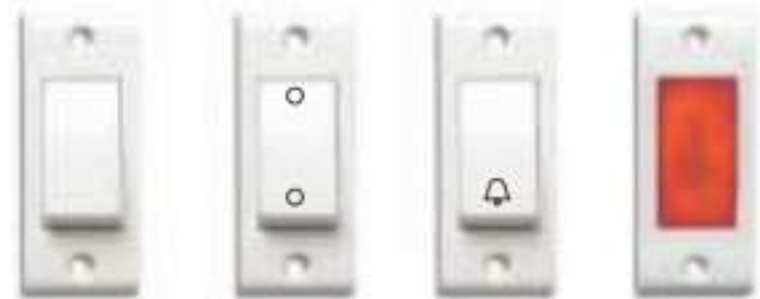

Code	Item	MRP ₹	Pkg. Outer/ Master
6A VAASTU SWITCH / INDICATOR			
GL701	1 Way Switch	27.00	20/1200
GL702	2 Way Switch	36.00	20/1200
GL703	Bell Push	36.00	20/1200
GL704	Indicator	39.00	20/1200

Code	Item	MRP ₹	Pkg. Outer/ Master
6A INNOVA SWITCH / INDICATOR			
GL705	1 Way Switch	26.00	20/1200
GL706	2 Way Switch	36.00	20/1200
GL707	Bell Push	36.00	20/1200
GL708	Indicator	39.00	20/1200

Code	Item	MRP ₹	Pkg. Outer/ Master
6A GENIUS SWITCH / INDICATOR			
GL709	1 Way Switch	26.00	20/1200
GL710	2 Way Switch	33.00	20/1200
GL711	Bell Push	33.00	20/1200
GL712	Indicator	36.00	20/1200

Code	Item	MRP ₹	Pkg. Outer/ Master
6A / 10A EIKON SOCKETS			
GL727	6A 3 Pin Socket (2M)	45.00	10/600

Code	Item	MRP ₹	Pkg. Outer/ Master
EIKON ELECTRONIC DIMMER / FAN REGULATOR			
GL735	Mini Dimmer	245.00	10/450
GL736	Medium Dimmer	263.00	10/300
GL737	4 Step Fan Regulator Switch Type	337.00	10/300
GL738	5 Step Fan Regulator Socket Type	371.00	10/300
- Regulator Supplied in ISI & Non ISI			

Code	Item	MRP ₹	Pkg. Outer/ Master
EIKON KIT-KAT FUSE / 6A S S COMBINED			
GL745	6A S. S. Combine with Indicator & Junction Box	122.00	10/160
GL746	10A Kit-Kat Fuse	55.00	20/600
GL747	16A Kit-Kat Fuse	69.00	10/300

Code	Item	MRP ₹	Pkg. Outer/ Master
16A EIKON SWITCH / 6 & 16A UNI. SOCKET			
GL750	16A 1 Way Switch	144.00	10/200
GL751	16A 2 Way Switch	168.00	10/200
GL752	6 & 16A Universal Socket with Safety Shutter	149.00	10/200



Code	Item	MRP ₹	Pkg. Outer/ Master
16A EIKON 3 IN ONE / WITH J. BOX			
GL753	3-in-one Universal Switch Socket Combined with Safety Shutter	222.00	5/100
GL754	3-in-one with Junction Box	266.00	5/100



Code	Item	MRP ₹	Pkg. Outer/ Master
16A EIKON 5 IN ONE / WITH J. BOX			
GL755	5-in-one Universal Switch Socket Combined With Fuse & Indicator with Safety Shutter	308.00	5/60
GL756	5-in-one With Junction Box	362.00	5/60



Code	Item	MRP ₹	Pkg. Outer/ Master
EIKON SKIRT LAMP HOLDER			
GL770	Angle Holder (Unbreakable)	61.00	20/400
GL771	Batten Holder (Unbreakable)	61.00	20/400



Code	Item	MRP ₹	Pkg. Outer/ Master
EIKON CEILING ROSE			
GL774	Pilot Ceiling Rose Unbreakable (3 Plate)	46.00	20/600
GL775	Jumbo Ceiling Rose Unbreakable (3 Plate)	56.00	20/400



With GOLDMEDAL,
you are in safe hands!



Safeguards human life
and property against
the hazards of electrical
mishaps.



IS/IEC-60898-1



IS/IEC-60898-1



IS/IEC-60898-1



IS/IEC-60898-1



IS/IEC-60898-1

Code	Item	Pole	MRP ₹	Pkg.
				Outer/ Master
ALLESSIO MINIATURE CIRCUIT BREAKER - 10kA C' CURVE - SP				
02301	6A MCB	1	240.00	10/200
02302	10A MCB	1	240.00	10/200
02303	16A MCB	1	240.00	10/200
02304	20A MCB	1	240.00	10/200
02305	25A MCB	1	240.00	10/200
02306	32A MCB	1	240.00	10/200
02307	40A MCB	1	470.00	10/200
02308	63A MCB	1	550.00	10/200
ALLESSIO MINIATURE CIRCUIT BREAKER - 10kA C' CURVE - SPN				
02311	6A MCB	2	680.00	6/120
02312	10A MCB	2	680.00	6/120
02313	16A MCB	2	680.00	6/120
02314	20A MCB	2	680.00	6/120
02315	25A MCB	2	680.00	6/120
02316	32A MCB	2	680.00	6/120
02317	40A MCB	2	1040.00	6/120
02318	63A MCB	2	1140.00	6/120
ALLESSIO MINIATURE CIRCUIT BREAKER - 10kA C' CURVE - DP				
02320	6A MCB	2	750.00	6/120
02321	10A MCB	2	750.00	6/120
02322	16A MCB	2	750.00	6/120
02323	20A MCB	2	750.00	6/120
02324	25A MCB	2	750.00	6/120
02325	32A MCB	2	750.00	6/120
02326	40A MCB	2	1100.00	6/120
02327	63A MCB	2	1220.00	6/120
ALLESSIO MINIATURE CIRCUIT BREAKER - 10kA C' CURVE - TP				
02330	6A MCB	3	1125.00	4/80
02331	10A MCB	3	1125.00	4/80
02332	16A MCB	3	1125.00	4/80
02333	20A MCB	3	1125.00	4/80
02334	25A MCB	3	1125.00	4/80
02335	32A MCB	3	1125.00	4/80
02336	40A MCB	3	1600.00	4/80
02337	63A MCB	3	1750.00	4/80
ALLESSIO MINIATURE CIRCUIT BREAKER - 10kA C' CURVE - TPN				
02340	6A MCB	4	1400.00	3/60
02341	10A MCB	4	1400.00	3/60
02342	16A MCB	4	1400.00	3/60
02343	20A MCB	4	1400.00	3/60
02344	25A MCB	4	1400.00	3/60
02345	32A MCB	4	1400.00	3/60
02346	40A MCB	4	1990.00	3/60
02347	63A MCB	4	2080.00	3/60

Code	Item	Pole	MRP ₹	Pkg.
				Outer/ Master
ALLESSIO MINIATURE CIRCUIT BREAKER - 10kA C' CURVE - FP				
02350	6A MCB	4	1590.00	3/60
02351	10A MCB	4	1590.00	3/60
02352	16A MCB	4	1590.00	3/60
02353	20A MCB	4	1590.00	3/60
02354	25A MCB	4	1590.00	3/60
02355	32A MCB	4	1590.00	3/60
02356	40A MCB	4	2150.00	3/60
02357	63A MCB	4	2250.00	3/60
ALLESSIO MINIATURE CIRCUIT BREAKER - 10kA B' CURVE - SP NEW				
02501	6A MCB	1	238.00	10/200
02502	10A MCB	1	238.00	10/200
02503	16A MCB	1	238.00	10/200
02504	20A MCB	1	238.00	10/200
02505	25A MCB	1	238.00	10/200
02506	32A MCB	1	238.00	10/200
02507	40A MCB	1	466.00	10/200
02508	63A MCB	1	545.00	10/200
ALLESSIO ISOLATOR - DP				
02360	40A Isolator	2	490.00	6/120
02361	63A Isolator	2	670.00	6/120
02362	100A Isolator	2	850.00	6/120
ALLESSIO ISOLATOR - TP				
02368	40A Isolator	3	760.00	4/80
02369	63A Isolator	3	950.00	4/80
02370	100A Isolator	3	1240.00	4/80
ALLESSIO ISOLATOR - FP				
02376	40A Isolator	4	1050.00	3/60
02377	63A Isolator	4	1300.00	3/60
02378	100A Isolator	4	1600.00	3/60
ALLESSIO CHANGEOVER - DP NEW				
02381	25A Changeover	2	950.00	6/120
02382	32A Changeover	2	1150.00	6/120
02383	40A Changeover	2	1380.00	6/120
02384	63A Changeover	2	1750.00	6/120
ALLESSIO CHANGEOVER - FP NEW				
02386	25A Changeover	4	2010.00	3/60
02387	32A Changeover	4	2300.00	3/60
02388	40A Changeover	4	2800.00	3/60
02389	63A Changeover	4	3300.00	3/60

IS/IEC-60898-1

IS/IEC-60898-1

IS/IEC-60898-1

IS/IEC-60898-1

IS/IEC-60898-1





IS/IEC:12640-1



IS/IEC:12640-1



Code	Item	Pole	MRP ₹	Pkg.	Outer/ Master
ALLESSIO RCCB - 10kA - DP					
02400	25A RCCB 30mA	2	2310.00	6/120	
02401	25A RCCB 100mA	2	2340.00	6/120	
02402	25A RCCB 300mA	2	2360.00	6/120	
02403	40A RCCB 30mA	2	2510.00	6/120	
02404	40A RCCB 100mA	2	2560.00	6/120	
02405	40A RCCB 300mA	2	2590.00	6/120	
02406	63A RCCB 30mA	2	3170.00	6/120	
02407	63A RCCB 100mA	2	3230.00	6/120	
02408	63A RCCB 300mA	2	3290.00	6/120	

Code	Item	Module	MRP ₹	Pkg.	Outer/ Master
ALLESSIO RCCB - 10kA - FP					
02412	25A RCCB 30mA	4	2850.00	3/60	
02413	25A RCCB 100mA	4	3000.00	3/60	
02414	25A RCCB 300mA	4	3110.00	3/60	
02415	40A RCCB 30mA	4	3000.00	3/60	
02416	40A RCCB 100mA	4	3049.00	3/60	
02417	40A RCCB 300mA	4	3170.00	3/60	
02418	63A RCCB 30mA	4	3400.00	3/60	
02419	63A RCCB 100mA	4	3520.00	3/60	
02420	63A RCCB 300mA	4	3630.00	3/60	

Code	Item	MRP ₹	Pkg.
02426	32A DP MCB with Enclosure	450.00	5/100

Code	Item	MRP ₹	Pkg.	NEW
AUTOMATIC CHANGEOVER WITH CURRENT LIMITER [ACCL] - SPN				
02451	Mains 32A, Genset 1.5A - 300W	2399.00	3/60	
02452	Mains 32A, Genset 2.5A - 500W	2399.00	3/60	
02453	Mains 32A, Genset 3A - 600W	2399.00	3/60	
02454	Mains 32A, Genset 4A - 800W	2399.00	3/60	
02455	Mains 32A, Genset 5A - 1000W	2399.00	3/60	
02456	Mains 32A, Genset 6A - 1200W	2399.00	3/60	
02457	Mains 32A, Genset 9A - 1800W	2399.00	3/60	
02458	Mains 32A, Genset 12A - 2400W	2399.00	3/60	
02459	Mains 32A, Genset 15A - 3000W	2399.00	3/60	
02460	Mains 32A, Genset 20A - 4000W	2399.00	3/60	
02461	Mains 32A, Genset 30A - 6000W	2399.00	3/60	

Code	Item	MRP ₹	Pkg.	NEW
02462	Mains 32A, Genset 32A - 6000W On site programmable DG Current limit 0-32A [With extra safety features]	3499.00	3/60	

Code	Item	MRP ₹	Pkg.	NEW
AUTOMATIC CHANGEOVER WITH CURRENT LIMITER [ACCL] - TPN WITH DISPLAY				
02463	Mains 40A, Genset 40A - 8000W	10999.00	1/4	
02464	Mains 63A, Genset 63A - 12000W On site programmable DG Current limit 0-40/63A [With extra safety features]	19950.00	1/4	



ALLESSIO ROTARY SWITCH				
02433	3 Way - 40A	928.00	1/40	
02434	3 Way - 63A	950.00	1/40	



ALLESSIO DOUBLE DOOR DB's - PLASTIC WITH METAL BASE						
04152	4 - 6 Way	2	-	4	1432.00	1/10
04153	7 - 9 Way	2	-	7	1706.00	1/10
04154	10 - 12 Way	2	-	10	2020.00	1/10
04155	13 - 16 Way	2	-	14	2403.00	1/5
04156	16 - 20 Way	2	-	18	2806.00	1/5

Fireproof Plastic with transparent grey cover



ALLESSIO SINGLE DOOR (METAL) DISTRIBUTION BOARD - IP30 - SPN						
04191	4 Way	2	-	2	1161.00	1/12
04192	8 Way	2	-	6	1452.00	1/9
04193	12 Way	2	-	10	1722.00	1/9
04194	16 Way	2	-	14	2145.00	1/6



•Conforms to IS 8623-1 & 3, IEC 61439-1 & 3 •IP-30.
•Suitable for Surface & Flush mounting. •Enclosure is made up of CRCA Sheet steel, RAL 9003 Powder coated, •with din rail, removable bus -bar, shrouded neutral/earth link with Conditional Short Circuit Rating of 15kA in SPN DB provided with isolable neutral link to carry out isolation test, also with high integrity/Clean Earth kit as accessory for electronic/IT installation to meet international safety standard DBs design with ample space for wiring. •There is a provision for DP MCB /Isolator/ RCCB/RCBO as incomer & SP MCBs as outgoing.

High performance delivered. Safely.



Air

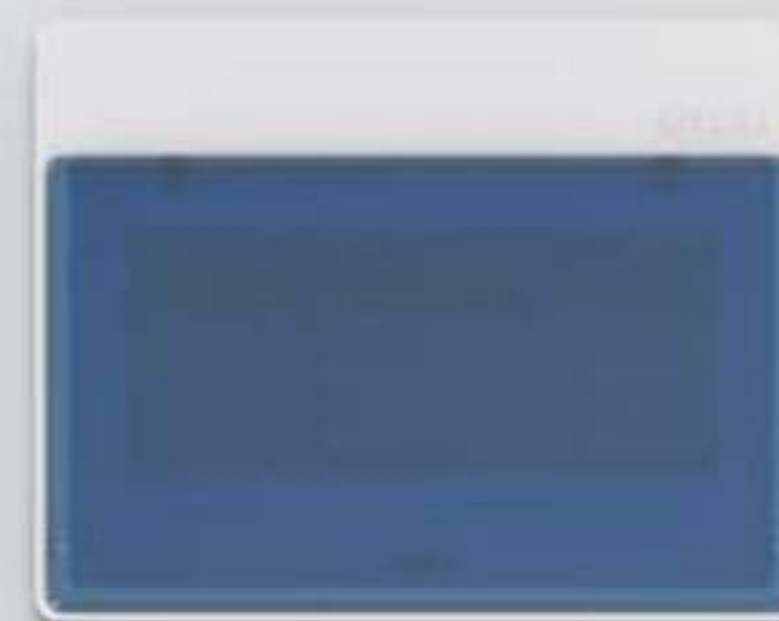

Air Double Door Plastic (DB)
with Transparent Textured Finish Door Flap



Technical Features

- Conforms to IS 8623-1&3, IEC 61439-1&3 standards.
- Suitable for Surface & flush mounting.
- Dust proof IP40 & IK07 compliant.
- Manufactured using Main Body - CRCA Sheet, Door - ABS & Door Flap - PC
- Main Body Fully powder coated with 7 tank pre-treatment process.
- Ample space provided for proper placement of neutral & earth wires.

Safe, reliable
and efficient.

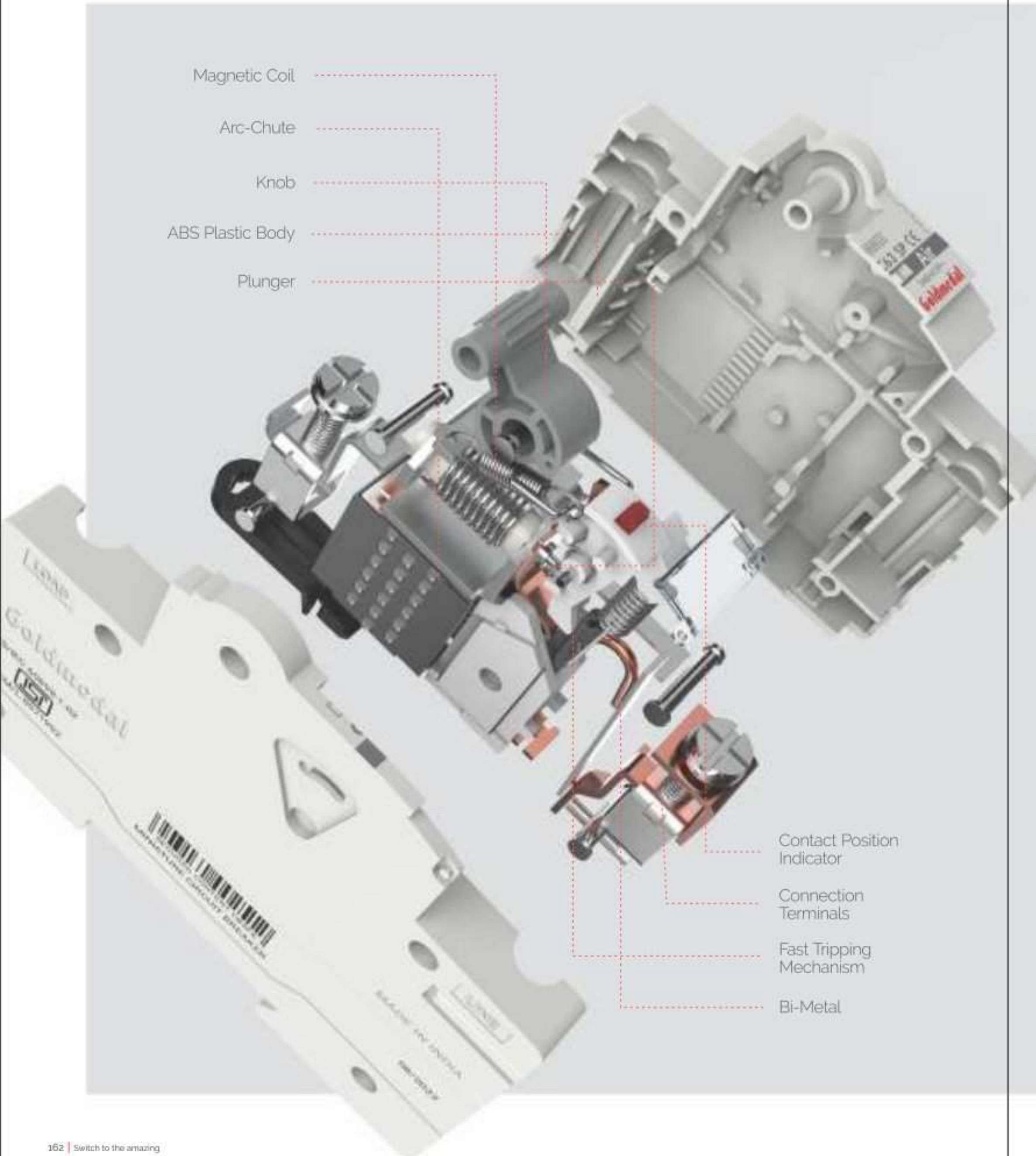

AirMCB

Compared to a traditional fuse, MCBs are designed to operate accurately under both overloading and short circuit conditions. Unlike a fuse, MCBs can also be reset quickly after they trips. RCCBs play an equally important role by automatically detecting and disconnecting the circuit whenever a fault occurs or the current exceeds the rated sensitivity. The MCBs and RCCBs from Goldmedal are housed within a plastic moulding that is made of flame-retardant, high strength plastic. The quality of the material used and its design ensures that these devices are highly durable and appear new in spite of years of use.

Maximum safety,
seamless power control.



AirRCCB | CHANGEOVER

Rapidly cuts off power during abnormal currents, preventing electric shock and enhancing home safety.

Code	Item	Pole	MRP ₹	Pkg. Outer/Master
NEW				
AIR MINIATURE CIRCUIT BREAKER - 10kA B' CURVE - SP				
07301	6A MCB	1	226.00	10/200
07302	10A MCB	1	226.00	10/200
07303	16A MCB	1	226.00	10/200
07304	20A MCB	1	226.00	10/200
07305	25A MCB	1	226.00	10/200
07306	32A MCB	1	226.00	10/200
07307	40A MCB	1	272.00	10/200
07308	63A MCB	1	318.00	10/200
NEW				
AIR MINIATURE CIRCUIT BREAKER - 10kA C' CURVE - SP				
07360	6A MCB	1	228.00	10/200
07361	10A MCB	1	228.00	10/200
07362	16A MCB	1	228.00	10/200
07363	20A MCB	1	228.00	10/200
07364	25A MCB	1	228.00	10/200
07365	32A MCB	1	228.00	10/200
07366	40A MCB	1	450.00	10/200
07367	63A MCB	1	520.00	10/200
NEW				
AIR MINIATURE CIRCUIT BREAKER - 10kA C' CURVE - SPN				
07370	6A MCB	2	650.00	6/120
07371	10A MCB	2	650.00	6/120
07372	16A MCB	2	650.00	6/120
07373	20A MCB	2	650.00	6/120
07374	25A MCB	2	650.00	6/120
07375	32A MCB	2	650.00	6/120
07376	40A MCB	2	990.00	6/120
07377	63A MCB	2	1050.00	6/120
NEW				
AIR MINIATURE CIRCUIT BREAKER - 10kA C' CURVE - DP				
07380	6A MCB	2	712.00	6/120
07381	10A MCB	2	712.00	6/120
07382	16A MCB	2	712.00	6/120
07383	20A MCB	2	712.00	6/120
07384	25A MCB	2	712.00	6/120
07385	32A MCB	2	712.00	6/120
07386	40A MCB	2	1050.00	6/120
07387	63A MCB	2	1140.00	6/120





IS/IEC:60898-1

Code	Item	Pole	MRP ₹	Pkg. Outer/ Master
AIR MINIATURE CIRCUIT BREAKER - 10kA C' CURVE - TP NEW				
07390	6A MCB	3	1068.00	4/80
07391	10A MCB	3	1068.00	4/80
07392	16A MCB	3	1068.00	4/80
07393	20A MCB	3	1068.00	4/80
07394	25A MCB	3	1068.00	4/80
07395	32A MCB	3	1068.00	4/80
07396	40A MCB	3	1500.00	4/80
07397	63A MCB	3	1650.00	4/80



IS/IEC:60898-1

Code	Item	Pole	MRP ₹	Pkg. Outer/ Master
AIR MINIATURE CIRCUIT BREAKER - 10kA C' CURVE - TPN NEW				
07400	6A MCB	4	1368.00	3/60
07401	10A MCB	4	1368.00	3/60
07402	16A MCB	4	1368.00	3/60
07403	20A MCB	4	1368.00	3/60
07404	25A MCB	4	1368.00	3/60
07405	32A MCB	4	1368.00	3/60
07406	40A MCB	4	1890.00	3/60
07407	63A MCB	4	1980.00	3/60



IS/IEC:60898-1

Code	Item	Pole	MRP ₹	Pkg. Outer/ Master
AIR MINIATURE CIRCUIT BREAKER - 10kA C' CURVE - FP NEW				
07410	6A MCB	4	1510.00	3/60
07411	10A MCB	4	1510.00	3/60
07412	16A MCB	4	1510.00	3/60
07413	20A MCB	4	1510.00	3/60
07414	25A MCB	4	1510.00	3/60
07415	32A MCB	4	1510.00	3/60
07416	40A MCB	4	2090.00	3/60
07417	63A MCB	4	2190.00	3/60



Code	Item	Pole	MRP ₹	Pkg. Outer/ Master
AIR ISOLATOR - DP NEW				
07420	40A Isolator	2	485.00	6/120
07421	63A Isolator	2	620.00	6/120
07422	100A Isolator	2	795.00	6/120



Code	Item	Pole	MRP ₹	Pkg. Outer/ Master
AIR ISOLATOR - TP NEW				
07428	40A Isolator	3	710.00	4/80
07429	63A Isolator	3	875.00	4/80
07430	100A Isolator	3	1180.00	4/80

Code	Item	Pole	MRP ₹	Pkg. Outer/ Master
AIR ISOLATOR - FP NEW				
07436	40A Isolator	4	975.00	3/60
07437	63A Isolator	4	1130.00	3/60
07438	100A Isolator	4	1440.00	3/60



Code	Item	Pole	MRP ₹	Pkg. Outer/ Master
AIR CHANGEOVER - DP NEW				
07446	25A Changeover	2	870.00	6/120
07447	32A Changeover	2	1100.00	6/120
07448	40A Changeover	2	1320.00	6/120
07449	63A Changeover	2	1680.00	6/120



Code	Item	Pole	MRP ₹	Pkg. Outer/ Master
AIR CHANGEOVER - FP NEW				
07451	25A Changeover	4	1770.00	3/60
07452	32A Changeover	4	2185.00	3/60
07453	40A Changeover	4	2675.00	3/60
07454	63A Changeover	4	3230.00	3/60



Code	Item	Pole	MRP ₹	Pkg. Outer/ Master
AIR RCCB - 10kA - DP NEW				
07460	25A RCCB 30mA	2	2260.00	6/120
07461	25A RCCB 100mA	2	2290.00	6/120
07462	25A RCCB 300mA	2	2310.00	6/120
07463	40A RCCB 30mA	2	2460.00	6/120
07464	40A RCCB 100mA	2	2510.00	6/120
07465	40A RCCB 300mA	2	2540.00	6/120
07466	63A RCCB 30mA	2	3120.00	6/120
07467	63A RCCB 100mA	2	3180.00	6/120
07468	63A RCCB 300mA	2	3240.00	6/120

IS/IEC:12640-1



Code	Item	Module	MRP ₹	Pkg. Outer/ Master
AIR RCCB - 10kA - FP NEW				
07472	25A RCCB 30mA	4	2800.00	3/60
07473	25A RCCB 100mA	4	2950.00	3/60
07474	25A RCCB 300mA	4	3060.00	3/60
07475	40A RCCB 30mA	4	2950.00	3/60
07476	40A RCCB 100mA	4	2999.00	3/60
07477	40A RCCB 300mA	4	3120.00	3/60
07478	63A RCCB 30mA	4	3350.00	3/60
07479	63A RCCB 100mA	4	3470.00	3/60
07480	63A RCCB 300mA	4	3580.00	3/60

IS/IEC:12640-1



Premium performance.
Ultimate protection.



AERO



Aero Double Door Plastic (DB)
with Transparent Door Flap



Technical Features

- Conforms to IS 8623-1&3, IEC 61439-1&3 standards
- Suitable for Surface & flush mounting
- Dust proof IP40 & IK07 compliant
- Manufactured using Main Body & Door - Heavy Duty Plastic Material
- Ample space provided for proper placement of neutral & earth wires.

Solving your electrical challenges, precisely.



AirecoDB

The AirEcoDB distribution boards are sleek, stylish and elegant in appearance. Its appearance reflects the supremely minimalistic look of the AIR Range to which it belongs. Its crisp, clean lines accentuate the powder-coated, superior finish and durability of the product. Suitable for flush and wall mounting, the AIR DBs offer ample space for easy installation of MCBs, RCCBs and for all the wiring required. The AIR Distribution Board also complies with all the standard requirements and is water and weather resistant so that it retains its international look even after years of use.

Code	Item	No of Modules			MRP ₹	Pkg. Outer/ Master
		Incomer	Sub Incomer	Outgoing		

AIR ECO DOUBLE DOOR [METAL] DB - IP42 - SPN

07211	4 Way	2	-	2	1288.00	1/12
07212	6 Way	2	-	4	1464.00	1/12
07213	8 Way	2	-	6	1776.00	1/8
07214	10 Way	2	-	8	2010.00	1/8
07215	12 Way	2	-	10	2322.00	1/8
07216	16 Way	2	-	14	2750.00	1/6

AIR ECO DOUBLE DOOR [METAL] DB - IP42 - TPN

07221	4 Way	6	-	4+4+4	3596.00	1/4
07222	6 Way	4	-	6+6+6	4216.00	1/4
07223	4 Way	8	-	4+4+4	4038.00	1/4
07224	6 Way	8	-	6+6+6	4291.00	1/4
07225	8 Way	8	-	8+8+8	4909.00	1/4
07226	12 Way	8	-	12+12+12	6526.00	1/1

•Conforms to IS 8623-1 & 3, IEC 61439-1 & 3 •Reversible Door for IP-42 & IK-09 Dbs.
 •Suitable for Surface & Flush mounting. •Enclosure is made up of CRCA Sheet steel, RAL 9002 Powder coated, •Ready to use DBs- includes 100A insulated Phase Bus-bar, Shrouded Neutral /Earth bar with Conditional short circuit Rating. This DB's kit includes high integrity accessories like Cement spill protector sheet, Colour-coded inter connecting wire set, Cable ties, Blank Module, Sticking saddles, Circuit identification labels. •There is a provision for-
 1) SPN: DP MCB /Isolator/ RCCB/RCBO as incomer & SP MCBs as outgoing.
 2) TPN: FP MCB /Isolator/ RCCB/RCBO as incomer & SP/TP MCBs as outgoing.

AIR ECO DD [METAL] DB IP-42 TPN 63A PHASE SELECTOR (without rotary switch & wiring)

07230	4 Way	6	-	4+4+4	4934.00	1/1
07231	4 Way	8	-	4+4+4	5198.00	1/1
07232	6 Way	8	-	6+6+6	6035.00	1/1
07233	8 Way	8	-	8+8+8	6988.00	1/1
07234	12 Way	8	-	12+12+12	8674.00	1/1

•Conforms to IS 8623-1 & 3, IEC 61439-1 & 3 •Reversible Door for IP-42 & IK -09 Dbs .
 •Suitable for Surface & flush mounting. •Enclosure is made up of CRCA Sheet steel, RAL 9002 Powder coated, •DB has two separate compartments for MCB & Phase selector Switches, 100A insulated Phase Bus-bar, Shrouded Neutral /Earth bar with Conditional Short Circuit Rating.
 •There is a provision for FP MCB /Isolator/RCCB/RCBO as incomer & SP/TP MCBs as outgoing.

AIR ECO DD [METAL] DB IP-42 TPN PHASE SELECTOR (with 40A Rotary switch & wiring)

07236	4 Way	6	-	4+4+4	8666.00	1/1
07237	4 Way	8	-	4+4+4	9094.00	1/1
07238	6 Way	8	-	6+6+6	10164.00	1/1
07239	8 Way	8	-	8+8+8	11234.00	1/1

AIR ECO DD [METAL] DB IP-42 TPN PHASE SELECTOR (with 63A Rotary switch & wiring)

07240	4 Way	6	-	4+4+4	9239.00	1/1
07241	4 Way	8	-	4+4+4	9875.00	1/1
07242	6 Way	8	-	6+6+6	11319.00	1/1
07243	8 Way	8	-	8+8+8	12474.00	1/1
07244	12 Way	8	-	12+12+12	14485.00	1/1

•Conforms to IS 8623-1 & 3, IEC 61439-1 & 3 •Reversible Door for IP-42 & IK -09 Dbs .
 •Suitable for Surface & flush mounting. •Enclosure is made up of CRCA Sheet steel, RAL 9002 Powder coated, •DB has two separate compartments for MCB & Phase selector Switches, which includes 3 Nos. of 40A/63A rotary switches, 3 Nos. of Rocker Switches for Phase identification, 100A insulated Phase Bus-bar, Shrouded Neutral /Earth bar with Conditional Short Circuit Rating. This DB's kit includes high integrity accessories like Cement spill protector sheet, Colour-coded inter connecting wire set, Cable ties, Blank Module, Sticking saddles, Circuit identification labels. •There is a provision for FP MCB /Isolator/RCCB/RCBO as incomer & SP/TP MCBs as outgoing.

AIR ECO [METAL] ENCLOSURE IP-42

07251	2 Way	-	2	-	-	1/40
07252	4 Way	-	4	-	-	1/24



Managing power was never so simple!



Atlantic **MCB**

Automatically breaks the circuit if the current reaches a predetermined value

Code	Item	Pole	MRP ₹	Pkg.
ATLANTIC MINIATURE CIRCUIT BREAKER - 10kA C' CURVE - SP				
04301	6A MCB	1	228.00	10/200
04302	10A MCB	1	228.00	10/200
04303	16A MCB	1	228.00	10/200
04304	20A MCB	1	228.00	10/200
04305	25A MCB	1	228.00	10/200
04306	32A MCB	1	228.00	10/200
04307	40A MCB	1	450.00	10/200
04308	63A MCB	1	520.00	10/200
ATLANTIC MINIATURE CIRCUIT BREAKER - 10kA C' CURVE - SPN				
04311	6A MCB	2	650.00	6/120
04312	10A MCB	2	650.00	6/120
04313	16A MCB	2	650.00	6/120
04314	20A MCB	2	650.00	6/120
04315	25A MCB	2	650.00	6/120
04316	32A MCB	2	650.00	6/120
04317	40A MCB	2	990.00	6/120
04318	63A MCB	2	1050.00	6/120
ATLANTIC MINIATURE CIRCUIT BREAKER - 10kA C' CURVE - DP				
04320	6A MCB	2	712.00	6/120
04321	10A MCB	2	712.00	6/120
04322	16A MCB	2	712.00	6/120
04323	20A MCB	2	712.00	6/120
04324	25A MCB	2	712.00	6/120
04325	32A MCB	2	712.00	6/120
04326	40A MCB	2	1050.00	6/120
04327	63A MCB	2	1140.00	6/120
ATLANTIC MINIATURE CIRCUIT BREAKER - 10kA C' CURVE - TP				
04330	6A MCB	3	1068.00	4/80
04331	10A MCB	3	1068.00	4/80
04332	16A MCB	3	1068.00	4/80
04333	20A MCB	3	1068.00	4/80
04334	25A MCB	3	1068.00	4/80
04335	32A MCB	3	1068.00	4/80
04336	40A MCB	3	1500.00	4/80
04337	63A MCB	3	1650.00	4/80
ATLANTIC MINIATURE CIRCUIT BREAKER - 10kA C' CURVE - TPN				
04340	6A MCB	4	1368.00	3/60
04341	10A MCB	4	1368.00	3/60
04342	16A MCB	4	1368.00	3/60
04343	20A MCB	4	1368.00	3/60
04344	25A MCB	4	1368.00	3/60
04345	32A MCB	4	1368.00	3/60
04346	40A MCB	4	1890.00	3/60
04347	63A MCB	4	1980.00	3/60





IS/IEC:60898-1



IS/IEC:60898-1



IS/IEC:60898-1



IS/IEC:60898-1



IS/IEC:60898-1

Code	Item	Pole	MRP ₹	Pkg.
ATLANTIC MINIATURE CIRCUIT BREAKER - 10kA C' CURVE - FP				
04350	6A MCB	4	1510.00	3/60
04351	10A MCB	4	1510.00	3/60
04352	16A MCB	4	1510.00	3/60
04353	20A MCB	4	1510.00	3/60
04354	25A MCB	4	1510.00	3/60
04355	32A MCB	4	1510.00	3/60
04356	40A MCB	4	2090.00	3/60
04357	63A MCB	4	2190.00	3/60

Code	Item	Pole	MRP ₹	Pkg.
ATLANTIC ISOLATOR - DP				
04360	40A Isolator	2	460.00	6/120
04361	63A Isolator	2	590.00	6/120
04362	100A Isolator	2	750.00	6/120

Code	Item	Pole	MRP ₹	Pkg.
ATLANTIC ISOLATOR - TP				
04368	40A Isolator	3	710.00	4/80
04369	63A Isolator	3	875.00	4/80
04370	100A Isolator	3	1180.00	4/80

Code	Item	Pole	MRP ₹	Pkg.
ATLANTIC ISOLATOR - FP				
04376	40A Isolator	4	975.00	3/60
04377	63A Isolator	4	1130.00	3/60
04378	100A Isolator	4	1440.00	3/60

Code	Item	Pole	MRP ₹	Pkg.
ATLANTIC RCCB - 10kA - DP				
04400	25A RCCB 30mA	2	2260.00	6/120
04401	25A RCCB 100mA	2	2290.00	6/120
04402	25A RCCB 300mA	2	2310.00	6/120
04403	40A RCCB 30mA	2	2460.00	6/120
04404	40A RCCB 100mA	2	2510.00	6/120
04405	40A RCCB 300mA	2	2540.00	6/120
04406	63A RCCB 30mA	2	3120.00	6/120
04407	63A RCCB 100mA	2	3180.00	6/120
04408	63A RCCB 300mA	2	3240.00	6/120

Code	Item	Pole	MRP ₹	Pkg.
ATLANTIC RCCB - 10kA - FP				
04412	25A RCCB 30mA	4	2800.00	3/60
04413	25A RCCB 100mA	4	2950.00	3/60
04414	25A RCCB 300mA	4	3060.00	3/60
04415	40A RCCB 30mA	4	2950.00	3/60
04416	40A RCCB 100mA	4	2999.00	3/60
04417	40A RCCB 300mA	4	3120.00	3/60
04418	63A RCCB 30mA	4	3350.00	3/60
04419	63A RCCB 100mA	4	3470.00	3/60
04420	63A RCCB 300mA	4	3580.00	3/60

Code	Item	Pole	MRP ₹	Pkg.
ATLANTIC CHANGEOVER - DP				
04430	25A Changeover	2	870.00	6/120
04431	32A Changeover	2	1100.00	6/120
04432	40A Changeover	2	1320.00	6/120

Code	Item	Pole	MRP ₹	Pkg.
ATLANTIC CHANGEOVER - FP				
04435	25A Changeover	4	1770.00	3/60
04436	32A Changeover	4	2185.00	3/60
04437	40A Changeover	4	2675.00	3/60

IS/IEC:60898-1



Control, protect, and manage power with ease.



homeguard
Main switch & Fuse units

The Homeguard fuse units protect against overloads & short circuits, cutting power during faults to prevent damage. They ensure safe maintenance, prevent electric shock, and offer easy ON/OFF control. Essential for safeguarding lives & property from electrical incidents, these devices are a crucial investment in safety.



Code	Item	MRP ₹	Pkg.
PORCELAIN KIT-KAT FUSE			
05101	16A / 240V	85.00	10/120
05102	16A / 415V (32A/240V)	141.00	10/80
05103	32A / 415V (63A/240V)	246.00	5/45
05104	63A / 415V	575.00	2/24



Code	Item	MRP ₹	Pkg.
PORCELAIN KIT-KAT FUSE WITH HANDLE			
05109	32A / 415V NEW	-	1/30
05110	63A / 415V NEW	-	1/12
05105	100A / 415V	1177.00	1/8
05106	200A / 415V	2041.00	1/6



Code	Item	MRP ₹	Pkg.
PORCELAIN KIT-KAT FUSE WITH HANDLE & BUSBAR LINK			
05114	63A / 415V NEW	-	1/12
05115	100A / 415V NEW	-	1/8
05116	200A / 415V NEW	-	1/6
05107	300A / 415V	3191.00	1/3
05108	500A / 415V	3764.00	1/3



Code	Item	MRP ₹	Pkg.
HRC FUSE HOLDER NEW			
05211	20 Amp	279.00	10/120
05212	32 Amp	359.00	10/120
05213	63 Amp	549.00	10/80
05214	125 Amp	1359.00	3/48



Code	Item	MRP ₹	Pkg.
SWITCH FUSE UNIT (REWIRABLE) DP			
05125	16A / 240V	755.00	1/18
05126	32A / 240V	1534.00	1/8
05134	16A / 415V NEW	-	1/4
05135	32A / 415V NEW	-	1/2





Code	Item	MRP ₹	Pkg.
SWITCH FUSE UNIT (REWIRABLE) TP			
05127	16A / 415V	2319.00	1/6
05128	32A / 415V	2756.00	1/4
05129	63A / 415V	7408.00	1/2
05130	100A / 415V	12664.00	1/1
05131	200A / 415V	16810.00	1/1

Code	Item	MRP ₹	Pkg.
SWITCH FUSE UNIT (REWIRABLE) TPN NEW			
05136	16A / 415V	-	1/6
05137	32A / 415V	-	1/4
05138	63A / 415V	-	1/2
05139	100A / 415V	-	1/1
05140	200A / 415V	-	1/1

Code	Item	MRP ₹	Pkg.
SHEET METAL CUT - OUT ENCLOSURE NEW			
05 142	32A / 415V	-	1/20
05 143	63A / 415V	-	1/6
05 144	100A / 415V	-	1/6

Code	Item	MRP ₹	Pkg.
L. T. CONTROL REVERSE FORWARD SWITCHES - PLASTIC HANDLE			
05147	16A / 240V	522.00	1/24
05148	25A-32A / 415V	816.00	1/18

Code	Item	MRP ₹	Pkg.
L. T. CONTROL REVERSE FORWARD SWITCHES - METAL HANDLE NEW			
05153	16A / 240V	-	1/24
05154	25A-32A / 415V	-	1/18

Code	Item	MRP ₹	Pkg.
CHANGEOVER SWITCH OFF LOAD - DP			
05159	16A / 240V	1296.00	1/12
05160	32A / 240V	1818.00	1/8
05161	63A / 240V	6677.00	1/3
05162	100A / 240V	-	1/1

Code	Item	MRP ₹	Pkg.
CHANGEOVER SWITCH OFF LOAD - TP			
05171	16A / 415V	1970.00	1/6
05172	32A / 415V	2406.00	1/4

Code	Item	MRP ₹	Pkg.
CHANGEOVER SWITCH OFF LOAD - FP			
05183	16A / 415V	2647.00	1/6
05184	32A / 415V	2952.00	1/4
05185	63A / 415V	8315.00	1/2
05186	100A / 415V	13255.00	1/1

•High grade porcelain carrier fitted with tinned copper fuse wire
•Switchgear enclosure made of CRCA sheet steel duly pre-treated and powder coated. •Hard bright tin plated contacts for high conductivity & longer life. •Quick make and break operating mechanism.

Code	Item	MRP ₹	Pkg.
CHANGE OVER SWITCH OFF LOAD - FP KNIFE TYPE NEW			
05192	63A/415V	-	1/2
05193	100A/415V	-	1/1
05187	200A/415V	23841.00	1/1
05188	320A/415V	-	1/1

•High grade porcelain carrier fitted with tinned copper fuse wire
•Switchgear enclosure made of CRCA sheet steel duly pre-treated and powder coated. •Hard bright tin plated contacts for high conductivity & longer life. •Quick make and break operating mechanism.

Code	Item	MRP ₹	Pkg.
AUTOMATIC CHANGEOVER SWITCH			
05201	32A / 240V - 2 Pole	2484.00	1/8

•High grade porcelain carrier fitted with tinned copper fuse wire
•Switchgear enclosure made of CRCA sheet steel duly pre-treated and powder coated. •Hard bright tin plated contacts for high conductivity & longer life. •Quick make and break operating mechanism.

Code	Item	MRP ₹	Pkg.
CAM OPERATED ROTARY SWITCH			
03232	3 Way - 25A	405.00	1/40
03233	3 Way - 32A	425.00	1/40
03234	3 Way - 40A	804.00	1/40
03235	3 Way - 63A	824.00	1/40

▪ Modular construction ▪ Enhanced life
▪ High Reliability ▪ Aesthetic design
▪ Temperature withstand capability
▪ Voltage impulse test



Creating amazing lifestyles.
Since 1979.



Ceiling Fans | Table, Wall & Pedestal Fans
Cabin & Portable Fans | Axial & Ventilation Fans



UPVC Round Conduit FRLS | Fittings



LED LIGHTING FITTING
Panel & Downlight | COB Downlight & Spot Light | Linear Light
Surface Light | Flood & Street Light | Bulkhead & Highbay
Batten & Lamp | Strip & Rope Light



FR | FR-LSH | ZHFR | HRFR | Tele. & Switchboard
Jelly Flooded Co-axial | Submersible 3 Core Flat & Service Cables
CTS & VIR Cables | Multicore Round Flexible
Computer & Lan Networking | CCTV & Speaker Cables



KNX Lifestyle Touch Panels & Push Buttons

Goldmedal is proud to present the world's most superior automation technology: the KNX Lifestyle Automation Solution.

Now, make your home smart and control it with ease, using the most modern, flexible, and stylish automation system available in the market. From young users to the oldest, every member in your family can use the soft touch push buttons, touch pads and switches to control every electrical aspect of your home. That's not all, they can even use their smart phones and tablets to control the system remotely from anywhere in the world.

The KNX Lifestyle Automation Solution incorporates all the latest technologies like DALI, Tunable White, RGB & RGB-W Control, Human Centric Lighting Control and is ready for all future upgrades.

From a single living room to a full commercial airport, Goldmedal's KNX Lifestyle Automation Solution has answers for all your automation needs. If you are thinking of automating your home or office, get in touch with us, now.



Lifestyle 27
7' Wall Mounted Touch Screen



Lifestyle 27
4' Wall Mounted Touch Screen



For order enquiries, please log into Dhan Barse App or call Customer Care at 91 9711 09 09 09. You can also write to us at automation@goldmedalindia.com



Lifestyle 09
Push Button with Room Temperature Control in Black Velvet



Lifestyle 09
Push Button with 6 Switches in Beige Velvet



Lifestyle 09
Push Button 8 Switches in Antique Copper



Lifestyle 09
Push Button 12 Switches in Antique Bronze



Lifestyle 07
3 Button Touch Switches in Alpine White



Lifestyle 07
4 Button Touch Switches in Silver Streak



Lifestyle 18
3 Button Touch Switches in Crystalline White

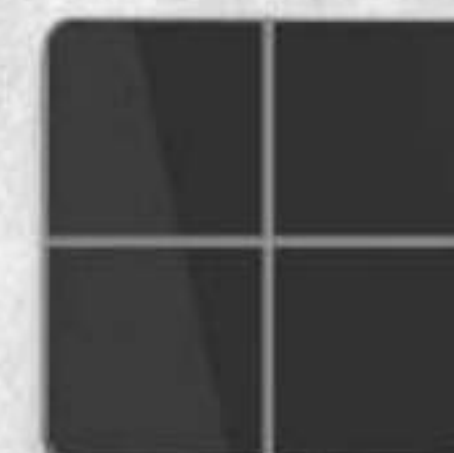

Lifestyle 18
4 Button Touch Switches in Crystalline Black



Lifestyle 90
Bluetooth Remote Control
White



Lifestyle 90
Bluetooth Remote Control
Black

IT'S A SWITCH. IT'S ALSO A REMOTE!

The GMesh remote controller is a switch-cum-remote control. You can fix it to a wall or a table and thus use it as a switch (wirelessly), or you can take it with you and use it as a remote control.

Goldmedal's GMesh technology gives you the comfort of a wired automation system without changing the existing wiring in your home. From switching to dimming to controlling fans and curtains, to RGB lighting control to tunable lighting control, everything is possible with GMesh. Add the Bluetooth based devices to your existing network and it's done. You do not need a Wi-Fi or an Internet connection to control your room functions. Just switch on Bluetooth on your mobile phone and connect to your home network!

Bluetooth Controller

G-Mesh products can handle DALI, Tunable White, RGB & RGB-W Control, Human Centric Lighting Control and is also ready for all future upgrades. While this may sound complex, it will surprise you to know that G-Mesh commissioning and set up is so simple that even a child can do it! Yes, even changing a lighting scenario is a simple task.



A2D0001 is a BLE-enabled 2 channel 0-10V or DALI controller. It has a universal 100-277V AC input voltage range and can control 2 separate analog channels. 1 Tunable White channel, or one Dali channel.



PWM0004 is a BLE-enabled four-channel PWM dimmer for constant voltage LED loads, such as LED strips and constant voltage LED modules. The same device can be used for both 12 and 24V DC LED strips. Separate drivers are not required for LED strip or RGB Strip dimming.



REL0004 is a BLE enabled 4 channel relay with 4 separate inputs to control BLE device on the network. The 4 inputs can be freely programmed to do operations like Dimming, curtains, master functions etc. The device can be used for curtain control also.



DCS0001 is a BLE-enabled DALI controller. It does not have its own power supply. Instead, it is powered directly from a DALI bus. DCS0001 can be used with a DALI sensor for presence detection or daylight harvesting or it can be used for controlling Human Centric Lighting (HCL).



TED0001 is a BLE-enabled trailing-edge dimmer for operation of incandescent lamps, dimmable LED lamps, and dimmable LED control gear. It can be installed in the ceiling, inside a luminaire, or into a ceiling outlet box.



ASD0001 is a BLE-control unit for LED drivers with 0-10V, 1-10V, or DALI dimming interface. The control output can be configured either as analogue 0-10V (and 1-10V) or as a digital standalone DALI control interface.



Solutions to all your automation needs under one roof!

If you are planning to build a new home or a commercial building, you are bound to face a number of technical and financial challenges. These challenges have only grown with time. At Goldmedal, we present you a one-stop, complete home automation solution, under one roof.



Whether it's a single room, the entire house, a building, or a huge office complex, Goldmedal has the products and skills to automate them for you. Your goals can range from energy efficiency to increasing productivity to enhancing your lifestyle to a mix of other needs... we can tailor our solutions as per your demands.

The way you interact with your home or office can also be customized. Besides traditional interfaces like wall switches, push buttons, and touch panels, you can also control the automation through our mobile apps, smart phones, tablets, and smart watches.

With Goldmedal, the answers to all your home automation needs is just one call away!

Bringing our world closer to you!

Experience the amazing - at your doorstep!

Presenting Goldmedal's Mobile Showroom - a never-before-seen concept in the world of wiring devices and accessories. Now, instead of visiting a showroom or a retail store, you can simply walk into this mobile store at a location nearest you. Designed by renowned automobile designer Dilip Chabria, this innovative yet thoughtfully crafted mobile showroom displays Goldmedal's latest products in a superbly premium environment.

There are multiple such mobile showrooms that ply the length and breadth of the country. You can track their movements online to check when one of them will be closest to your location. There are no reservations to be made. Just walk up to the mobile store and you will be welcomed with open doors! A Goldmedal executive in the showroom will be happy to assist you. We look forward to seeing you inside our amazing store!

MOBILE SHOWROOM FEATURES

- LED Displays
- AC Environment
- Stylish, Ambient Light
- Multi Product Display
- Interactive Touch Screen
- Live GPS Tracking
- Executive Available



Goldmedal

Walk in – and be amazed!

Walk into Goldmedal's Mobile Showroom and be ready to get amazed! This unique showroom on wheels proudly displays the latest and the most innovative products from the company in a contemporary and aesthetically appealing environment that you now associate with the Goldmedal brand.

We welcome you to touch, feel, and interact with each of the products on display. There is no time limit for your visit. If you have a question, an experienced Goldmedal executive will be at hand to provide you all the information you need.

SHOWROOMS

WEST

MUMBAI

E-1, Laxmi Industrial Estate,
New Link Road,
Andheri West, Mumbai - 400053
Tel: +91-22-40031075
Email: info@goldmedalindia.com

AHMEDABAD

106, Arista, 1st Floor, Opp Stellar,
Sindhu Bhavan Road, Ahmedabad - 380058
+91-8104965389
Email: info@goldmedalindia.com

EAST

KOLKATA

Merlin Homeland Mall, Shop No. 123, 1st Floor,
18B, Ashutosh Mukherjee Road, Bhawanipore,
Kolkata - 700 020. Tel: +91- 8336956017
Email: kolkata@goldmedalindia.com

SILIGURI

International Market, 2nd Floor, Shop No. 3 & 4,
Sevoke Road, Near Panitanki More,
Beside Sky Star Building, Siliguri - 734001,
West Bengal. Tel: +91-8336084284
Email: riteshg@goldmedalindia.co.in

GUWAHATI

1st Floor Patwari Enclave, Kachari Basti, Near Dispur
Collage, Ganeshguri, Guwahati - 781005.
Tel: +91- 9718077070.
Email: guwahati@goldmedalindia.com

RANCHI

B Square, Plot no.189, Beside Girdhar Plaza,
Harmu Road, Ranchi-834001.
Tel: +91- 9431170402
Email: ranchi@goldmedalindia.com

NORTH

JODHPUR

Plot No. E-99A, M. I. A.
Basni 2nd Phase, Jodhpur,
Rajasthan - 342005.
+91-9772210543
Email: rajasthan@goldmedalindia.com

NOIDA

H-204, Sec-63
Noida, Uttar Pradesh - 201307
Tel: +91-120-4135901
Email: noida@goldmedalindia.com

JAIPUR

Goldmedal Electricals Private Limited
55, New Aatish Market, Mansarovar,
Jaipur - Rajasthan.
Tel: +91-291-3261955
Email: rajasthan@goldmedalindia.com

JALORE

Head Post Office Road,
Jalore - 343001, Rajasthan, India,
Tel: +91-2973222568
Email: rajasthan@goldmedalindia.com

SOUTH

HUBBALLI

Umachagi Complex, Koppikar Road, Hubballi,
Karnataka-580020.
Tel: +91-0836-4258466
Email: bangalore@goldmedalindia.com

HYDERABAD

Kothari Landmark 5-2-58/67, Jambagh,
Hyderabad-500 001.
Tel: +91-040-29706099
Email: hyderabad@goldmedalindia.com

VIJAYAWADA

2nd Floor, PVP Mall, Mahatma Gandhi Rd,
Labbipet, Vijayawada-520010, Andhra Pradesh
Tel: +91-9885676400
Email: vijayawada@goldmedalindia.com

VIJAYAWADA

D. NO. 11-33-15, Tatakulavari Street,
Vijayawada-520 001, Andhra Pradesh
Tel: +91-866-6542000 / 8977574737
Email: vijayawada@goldmedalindia.com

KADAPA

21/96, Reddy Complex, Near 7 Road Circle,
Opp. Reddy Express, Kadapa- 516001, Andhra
Pradesh.
Tel: +91-9885676400
Email: vijayawada@goldmedalindia.com

CALICUT

Shaherzad Shopping Complex, CH Flyover Junction,
Cherrooty Road, Calicut - 673001, Kerala.
Tel: +91-9048743111
Email: calicut@goldmedalindia.com

COCHIN

3rd Floor, G K Arcade, Palarivattom Bye Pass Junction,
Ernakulam - 682028, Kerala.
Tel: +91-9324936290
Email: calicut@goldmedalindia.com

COIMBATORE

D.No. 897, Avinashi Road,
Below Flyover,
Coimbatore-641018.
Tel: +91-9324514945
Email: chennai@goldmedalindia.com

BRANCHES

WEST

MUMBAI

119, Maskati Mahal, 3rd Floor, Room
No.1- B, Loharchawl, Marine Line,
Mumbai - 400002, Maharashtra, India,
Tel: +91-22-69333558/511
Mob.: 9320687515
Email: info@goldmedalindia.com

PALGHAR

Bldg. No.5, Shah Industrial Estate,
Opp. Masjid, Mourya Naka, Sativali,
Vasai (E), Palghar-401208, Maharashtra
Tel: +91-22-42023026
Email: mumbai@goldmedalindia.com

PUNE

741/1, Shop No.1 & 2, Ground Floor,
Kushal Sagar Complex, Ganesh Road,
Budwar Peth, Pune - 411002,
Maharashtra, India. Tel: +91-9822098620
Email: pune@goldmedalindia.com

AHMEDABAD

Block No. 43, Behind Savex Technologies
Warehouse, Sanathal Bakrol Ring Road,
Village Badrabad, Ahmedabad,
Gujarat- 382210
Tel: +91-9372200393
Email: ahmedabad@goldmedalindia.com

BHOPAL

Way No. 11-12, Multi Industries
Warehouse, Plot No. 13C, Industrial Area
Govindpura, Bhopal,
Madhya Pradesh - 462023
Tel: +91-9589080144
Email: bhopal@goldmedalindia.com

RAIPUR

1st Floor, Plot No.15, Kedia Business Park,
Tatibandh, Raipur, Raipur - 492099,
Chhattisgarh, India.
Tel: +91-7714910078
Email: raipur@goldmedalindia.com

EAST

KOLKATA

1/1B/4, Ram Krishna Naskar Lane
Beliaghata, Kolkata - 700010
West Bengal.
Tel: +91-8336907040
Email: kolkata@goldmedalindia.com

PATNA

Plot No.846, Mohalla East Ashu Chak,
Po. Purvilakshmi Nagar, Krishna Niketan
School Road, Agamkuan, Patna-800030,
Bihar, India. Tel: +91-9798606400
Email: patna@goldmedalindia.com

RANCHI

R S Plot No.2072, Near Dalaidali Chowk,
Simaliya, P. S. Ratu, Ranchi - 834005,
Jharkhand, India.
Tel: +91- 9431170402
Email: ranchi@goldmedalindia.com

GUWAHATI

Ist Floor Patwari Enclave, Kachari Basti,
Near Dispur Collage, Ganeshguri,
Guwahati - 781005.
Tel: +91- 9718077070.
Email: guwahati@goldmedalindia.com

CUTTACK

Plot No.1047 & 1048, Opp. Axis Bank,
Jagatpur, Cuttack- 754021, Odisha
(Orissa), India, Tel: +91- 9437452303
Email: cuttack@goldmedalindia.com

NORTH

JODHPUR

Plot no. E-99A, M. I. A.
Basni 2nd Phase, Jodhpur,
Rajasthan - 342005.
Tel: +91-9772210543
Email: rajasthan@goldmedalindia.com

LUCKNOW

C1 - 5, Phase-2, Transport Nagar,
Lucknow - 226012, Uttar Pradesh, India.
Tel: +91-8780887400
Email: lucknow@goldmedalindia.com

NOIDA

H-204, Sec-63, Noida,
Uttar Pradesh - 201307
Tel: +91-120-4135901
Email: noida@goldmedalindia.com

MOHALI

855/C, Janta Industrial Estate,
Sector - 82, Mohali, Mohali-160055,
Punjab, India.
Customer Care : 9711 09 09 09
Email: mohali@goldmedalindia.com

BENGALURU

Level 2/3/4, Regal Arcade No. 1-2,
5th Cross, Mysore Road, Bengaluru,
Karnataka - 560026
Tel: +91-80-41687799/41759977
Email: bangalore@goldmedalindia.com

VIJAYAWADA

20-127/2, By Pass Road, Gollapudi,
Krishna District, Vijayawada - 521225,
Andhra Pradesh
Tel: +91-866-6542333/6542888
Email: vijayawada@goldmedalindia.com

HYDERABAD

Kothari Landmark 5-2-58/67, Jambagh,
Hyderabad-500 001.
Tel: +91-040-29706099
Email: hyderabad@goldmedalindia.com

CHENNAI

92/6, Nattu Pillaiar Koil Street
Sowcarpet, Chennai - 600001,
Tamil Nadu, India.
Tel: +91-44-49521008
Email: chennai@goldmedalindia.com

CALICUT

Door No.1/60, Baby Marine Export
Compound, Temple Road,
West Hill Calicut, Kozhikode (Calicut),
Kozhikode-673005, Kerala, India.
Customer Care : 9711 09 09 09
Email: calicut@goldmedalindia.com

OUR CLIENTELE

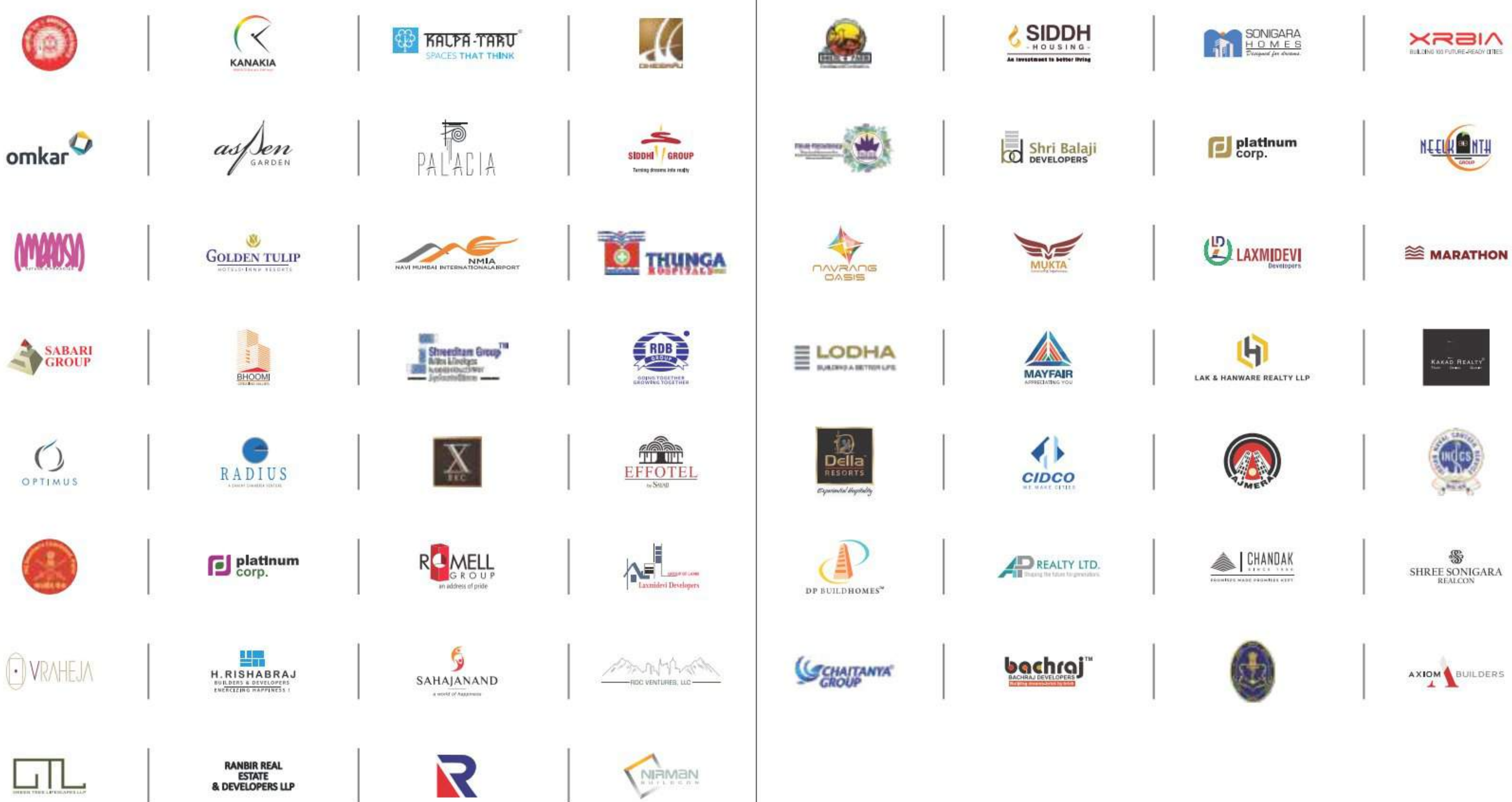

NOTES

NOTES

Brand Identity, Concept &
Design copyright by
GOLDMEDAL ELECTRICALS PVT. LTD.

www.goldmedalindia.com

Commercial Term & Conditions

- All prices are in Indian Rupees inclusive of GST) •
Prices mentioned in this price list are of standard
products • Warranty applicable on products are as
per Goldmedal's warranty policy • Prices are
subject to change without prior notice • This price
list supersedes all previous price lists • Continuous
design and product development is a routine
practice at Goldmedal, so data in this price list
provided may change without prior information or
notice. Customers are advised to check current
data before purchasing any product.